

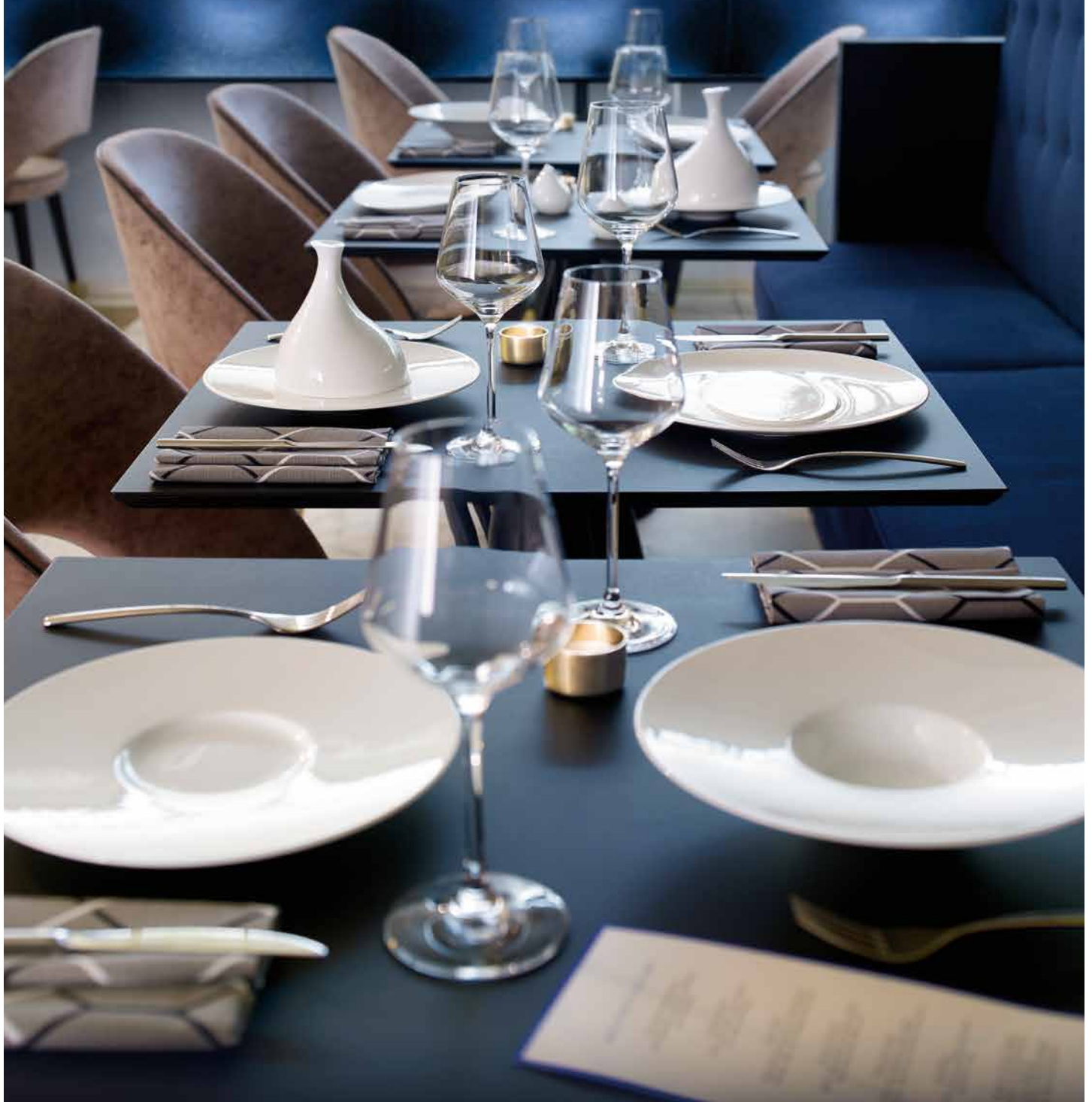

Villeroy & Boch
1748

CREATING HOSPITALITY 2022|2023





CONTENT

INTRO		PREMIUM PORCELAIN			PREMIUM PORCELAIN - like.			GLASSWARE	
Tradition	6	<i>Range Overview</i>	24	Iconic La Boule	94	<i>Range Overview</i>	161	Stella Cosmo	222
Innovation	8	Affinity	26	La Scala	98	Crafted	162	Stella Vogue	226
Quality	10	Amarah	34	La Scala Patina	104	To Go & To Stay	168		
Service	12	Artesano Professionale	40	Marchesi	108	Coffee To Go	172	CUTLERY	
Responsibility	14	Artesano Barista	46	Neufchâtel Care	112	To Go	176	<i>Range Overview</i>	233
Trends & Diversity	16	Artesano Provençale	52	NewMoon	116			Blacksmith	234
Custom Made Solutions	18	Bella	56	NewWave	120	PREMIUM BONE PORCELAIN		Bourgogne	238
References	20	Caffè Club	60	Pi Carré	126	<i>Range Overview</i>	185	Coupole	242
		Cera	64	Sedona	130	Anmut Gold	186	Kreuzband	246
		Copper Glow	68	Sedona Function	136	Anmut Platinum	190	NewWave	250
		Corpo	72	The Rock	140	Blossom	194	Oscar	254
		Dune	78	Universal	148	MetroChic	198	Piemont	258
		Easy	84	Urban Nature	154	MetroChic blanc	204	Udine	262
		Flow	90			Modern Grace	208	Victor	266
						Stella Hotel	212		
								SALES CONTACT	295
								CARE INSTRUCTIONS	300

CREATING *Hospitality*

OUR CREATIVE PHILOSOPHY:
passion, innovation, professionalism,
design, quality, responsibility

NOTRE PHILOSOPHIE CRÉATIVE :
passion, innovation, professionnalisme,
design, qualité, responsabilité

UNSERE KREATIVE PHILOSOPHIE:
Leidenschaft, Innovation, Professionalität,
Design, Qualität, Verantwortung

NUESTRA FILOSOFÍA CREATIVA:
pasión, innovación, profesionalidad, diseño,
calidad, responsabilidad

LA NOSTRA FILOSOFIA CREATIVA:
passione, innovazione, professionalità,
design, qualità, responsabilità



A PREMIUM BRAND WITH *Tradition*

Villeroy & Boch has been synonymous with high-quality tableware since its foundation in 1748. Whether porcelain, glass or cutlery, a wealth of expertise come together to create the finest tableware boasting excellent quality standards, a variety of distinctive designs and first-class functionality. The best prerequisites for “Creating Hospitality”.

Depuis 1748, Villeroy & Boch est synonyme d'arts de la table haut de gamme au style caractéristique. Son expertise la plus pointue a donné vie à des séries d'arts de la table (porcelaine, verres, couverts de table) de qualité exceptionnelle, alliant designs incomparables et fonctionnalité hors pair. Des atouts idéals pour « Creating Hospitality ».

Seit der Gründung im Jahr 1748 steht Villeroy & Boch für hochwertige, stilprägende Tischkultur. Ob Porzellan, Glas oder Besteck: Aus höchster Expertise entstehen Tischkulturserien mit überragenden Qualitätsstandards, unverwechselbarer Designvielfalt und erstklassiger Funktionalität. Die besten Voraussetzungen für „Creating Hospitality“.

Desde su fundación en 1748, Villeroy & Boch es sinónimo de menaje de mesa de alta calidad y estilo. Ya sea porcelana, cristalería o cubertería, gracias a los más amplios conocimientos, creamos menaje de mesa de calidad extraordinaria, una variedad de diseño inconfundible y la máxima funcionalidad. Los mejores requisitos para “Creating Hospitality”.

Dalla sua fondazione nel 1748, Villeroy & Boch è sinonimo di articoli di alta qualità e stile all'avanguardia. Che si tratti di porcellana, bicchieri o posate: dalle più elevate competenze nascono le serie di articoli di qualità superiore, inconfondibile varietà nel design e ottima funzionalità. I migliori presupposti per “Creating Hospitality”.



Historic headquarters: the Old Abbey



Innovation

Villeroy & Boch production stands for the highest quality - from the careful selection of raw materials to the use of lead-free, double-fired glazes and decorative paints that have been tested for harmful substances, as well as innovative manufacturing processes that enable extraordinary designs. The result is the best porcelain quality, made in Germany.

La production de Villeroy & Boch incarne la plus haute qualité : sélection minutieuse des meilleures matières premières, utilisation d'émaux sans plomb à deux cuissons et de peintures certifiées sans substances toxiques, procédés de fabrication innovants pour des designs prodigieux. Il en résulte la meilleure qualité de porcelaine Made in Germany.

Die Produktion von Villeroy & Boch steht für höchste Qualität: Von der sorgfältigen Auswahl hochwertiger Rohstoffe über die Verwendung bleifreier Zwei-Brand-Glasuren und schadstoffgeprüfter Dekorfarben bis hin zu innovativen Herstellungsverfahren, die außergewöhnliche Designs ermöglichen. Das Ergebnis ist beste Porzellanqualität made in Germany.

Villeroy & Boch es sinónimo de máxima calidad: desde la selección de materias primas y el uso de esmaltes bicocción sin plomo y colores decorativos sometidos a pruebas de sustancias nocivas, hasta los innovadores procesos de fabricación para unos diseños extraordinarios. El resultado es una porcelana de la mejor calidad "made in Germany".

La produzione Villeroy & Boch è sinonimo di massima qualità: dall'accurata scelta delle materie prime all'uso di smalti senza piombo a doppia cottura e di colori decorativi senza sostanze nocive, sino all'impiego di tecniche produttive innovative che consentono di ottenere motivi straordinari. Il risultato è la migliore porcellana made in Germany.



The innovative design of NewMoon

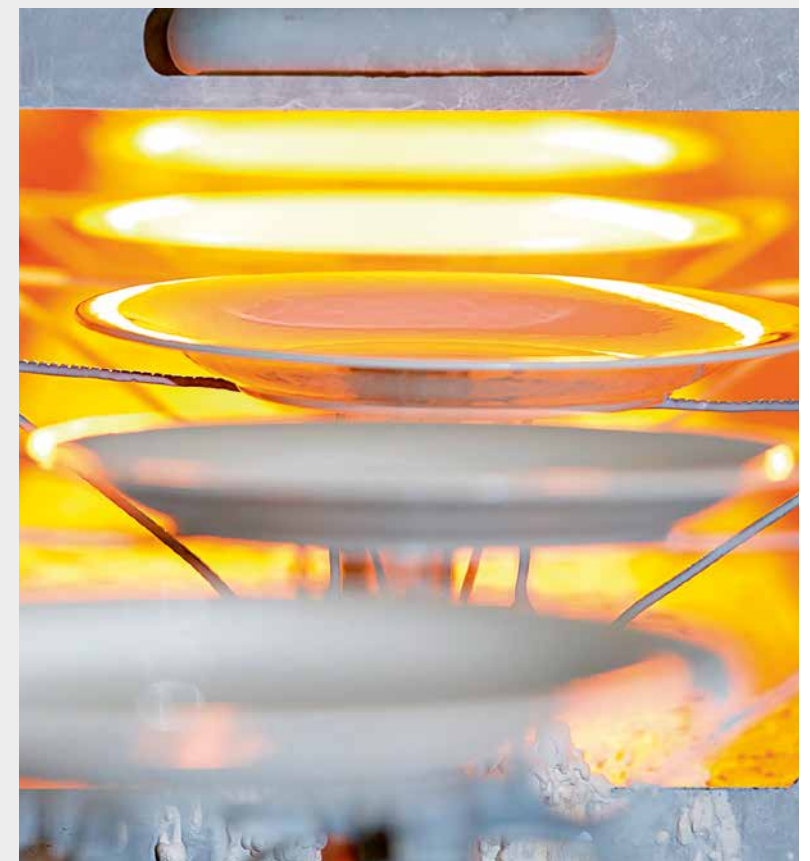

Quality & FUNCTIONALITY

The high-quality hotel tableware from Villeroy & Boch is ideally aimed at the needs of gastronomy and the hotel industry:

- Complete range with stackable shapes
- Easy to clean and optimal storage
- Dishwasher, grill and microwave-safe
- 10-year edge-chip warranty

La vaisselle hôtelière de haute qualité de Villeroy & Boch est destinée à répondre à la perfection aux besoins de la restauration et de l'hôtellerie :

- Offre complète aux formes empilables
- Lavage facile et rangement optimal
- Résistance au lave-vaisselle, à la salamandre et au four à micro-ondes
- Garantie de 10 ans contre les ébréchures

Die hochwertigen Hotelgeschirre von Villeroy & Boch sind hervorragend auf die Bedürfnisse der Gastronomie und Hotellerie ausgerichtet:

- Komplettangebot mit stapelbaren Formen
- Einfache Reinigung und optimale Lagerung
- Spülmaschinen-, Salamander- und Mikrowellenfestigkeit
- 10-Jahres-Garantie auf Kantenschlagfestigkeit

La vajilla de hostelería de alta calidad de Villeroy & Boch está excelentemente adaptada a las necesidades de la restauración y la hostelería:

- Oferta completa con diseño apilable
- Limpieza sencilla y almacenamiento óptimo
- Resistencia a lavavajillas, salamandras y microondas
- 10 años de garantía de resistencia frente a golpes en los bordes

Le porcellane per hotel di Villeroy & Boch rispondono perfettamente alle esigenze della ristorazione e del settore alberghiero:

- Gamma completa con forme impilabili
- Pulizia facile e stoccaggio ottimale
- Resistenza a lavastoviglie, salamandra e microonde
- Garanzia di 10 anni sulle scheggiature



Production of tableware



Quality check

Service

The Hospitality Division offers expert and solution-oriented assistance in more than 120 countries - before, during and after the purchase. In addition to professional logistics, Villeroy & Boch guarantees constant delivery availability for select tableware, glass and cutlery series with the AAA programme - Article Always Available.

La division Hospitality offre, avec ses partenaires dans plus de 120 pays, un soutien compétent proposant des solutions, avant, pendant et après l'achat. Outre sa logistique professionnelle, Villeroy & Boch garantit la disponibilité constante d'une sélection de séries de vaisselle, verres et couverts via le programme AAA - Article Always Available.

Die Hospitality Division bietet mit Partner:innen in mehr als 120 Ländern eine kompetente und lösungsorientierte Betreuung - vor, während und nach dem Kauf. Neben einer professionellen Logistik garantiert Villeroy & Boch mit dem Programm AAA - Article Always Available - die ständige Lieferbarkeit für ausgewählte Geschirr-, Glas- und Besteckserien.

Con socios y socias en más de 120 países, la División Hospitality ofrece un buen asesoramiento centrado en soluciones antes, durante y después de la compra. Además de la logística, Villeroy & Boch garantiza la disponibilidad constante de las gamas de vajilla, cristalería y cubertería seleccionadas para el programa AAA (Article Always Available).

La divisione Hospitality, con partner in oltre 120 paesi, offre ai suoi clienti una consulenza competente, prima, durante e dopo l'acquisto. Oltre a una logistica professionale, Villeroy & Boch garantisce la disponibilità costante di serie di stoviglie selezionate, bicchieri e posate con il programma AAA - Article Always Available.



Responsibility

Economy, environment and social. Villeroy & Boch is committed to the well-being of our employees and fellow human beings, and to the production of sustainable products. The efficient use of raw materials and energy as well as the reduction of emissions are therefore key components of our environmental strategy.

Économie, écologie et responsabilité sociale. Villeroy & Boch assume pleinement ses responsabilités liées à la durabilité des produits ou envers ses salariés et leurs semblables. L'utilisation efficace des matières premières et de l'énergie, et la réduction des émissions constituent ainsi des éléments essentiels de notre stratégie environnementale.

Ökonomie, Ökologie und Soziales. Villeroy & Boch hat es sich zur Aufgabe gemacht, Verantwortung sowohl für nachhaltige Produkte als auch für Mitarbeiter:innen und Mitmenschen zu übernehmen. Der effiziente Einsatz von Rohstoffen und Energie sowie die Reduktion von Emissionen sind daher wesentlicher Bestandteile unserer Umweltstrategie.

Economía, ecología y cuestiones sociales. Villeroy & Boch se ha propuesto asumir la responsabilidad de los productos sostenibles, así como de su personal y el resto de seres humanos. El uso eficiente de las materias primas y la energía, así como la reducción de las emisiones, son por tanto componentes esenciales de nuestra estrategia medioambiental.

Economia, ecologia e questioni sociali. Villeroy & Boch si è impegnata ad assumersi la responsabilità sia per i prodotti sostenibili, sia per i dipendenti e gli altri esseri umani. L'impiego efficiente delle materie prime e dell'energia, nonché la riduzione delle emissioni, sono quindi componenti essenziali della nostra strategia ecologica.



Own cogeneration unit for efficient energy

Trends

& DIVERSITY

From banquets and fine dining to eco-friendly take-away solutions and hip trendy designs, such as our Pottery style - the Villeroy & Boch product range is particularly diverse and offers high-quality products in premium quality, which are ideal for professional use in gastronomy and the hotel industry.

Qu'il s'agisse de banquets ou de cuisine gastronomique, de solutions de vente à emporter respectueuses de l'environnement ou de designs tendance comme le style poterie : le vaste assortiment de Villeroy & Boch est polyvalent et propose des produits d'une qualité exceptionnelle, parfaits pour les professionnels de la restauration et l'hôtellerie.

Von Bankett über Fine Dining bis hin zu umweltfreundlichen Take-Away Lösungen oder angesagten Trenddesigns wie dem Pottery-Style: Das breite Sortiment von Villeroy & Boch ist besonders vielseitig und bietet hochwertige Produkte in bester Premiumqualität, die perfekt geeignet sind für den professionellen Einsatz in der Gastronomie und Hotellerie.

Desde banquetes y alta cocina hasta soluciones ecológicas para llevar o diseños de moda como estilo de cerámica: la amplia gama de Villeroy & Boch es especialmente versátil y ofrece productos de primera calidad que se adaptan perfectamente al uso profesional en la restauración y la hostelería.

Dai banchetti al Fine Dining, alle soluzioni da asporto attente all'ambiente o ai design di tendenza come lo stile Pottery: L'ampia gamma di Villeroy & Boch è particolarmente versatile e offre prodotti pregiati nella migliore qualità premium, che sono perfettamente adatti per l'uso professionale nella ristorazione e nel settore alberghiero.

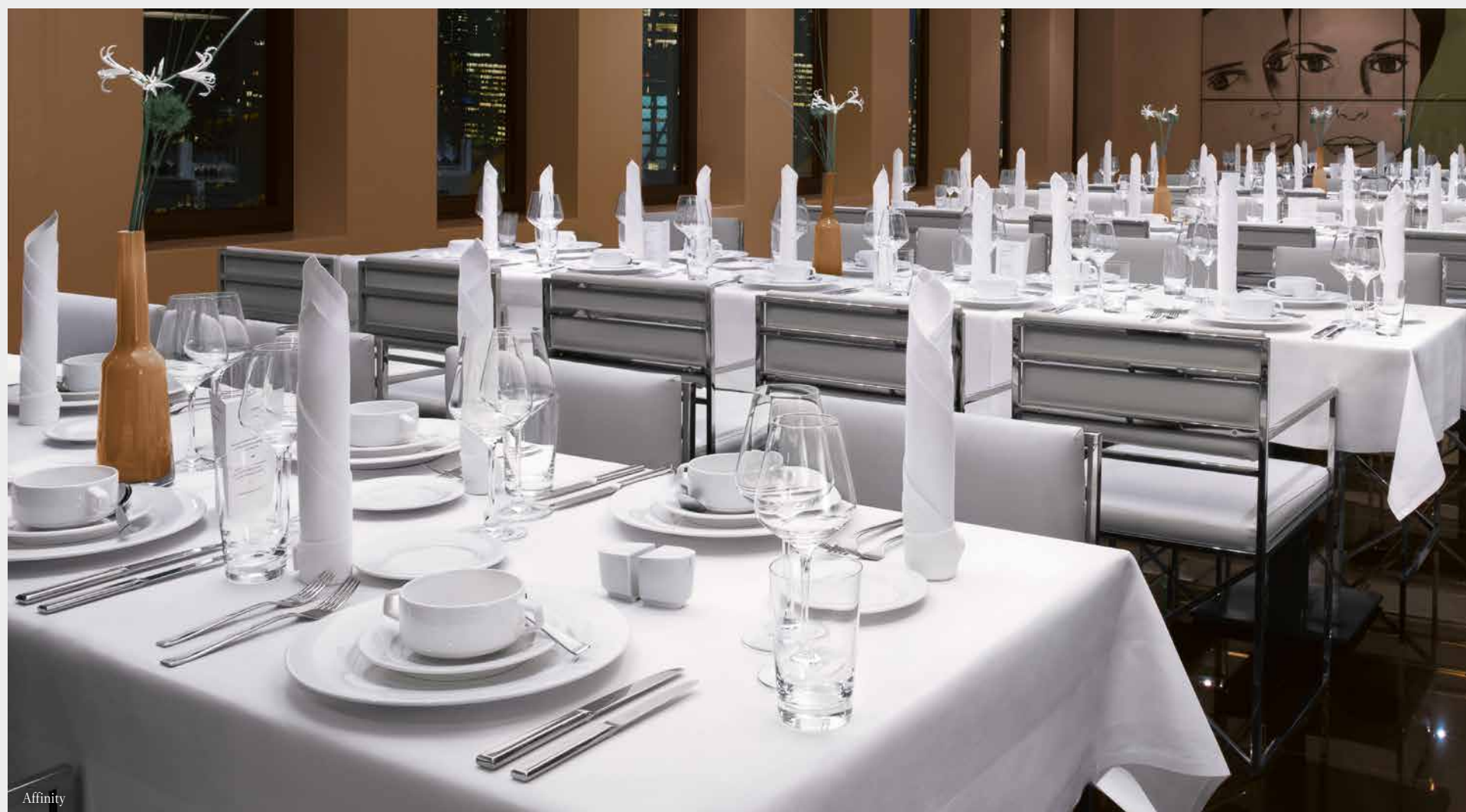

CUSTOM MADE *Solutions*

Villeroy & Boch offers a comprehensive overall concept of premium tableware and professional “Custom Made Solution” services. Perfectly tailored to your individual requirements, we decorate our high-quality porcelain with your trademark or emblem, including characteristic slogans or a design of your choosing.

Villeroy & Boch propose un concept global complet d'arts de la table de haute qualité et de services professionnels de solutions sur mesure. Afin de répondre à vos besoins individuels, nous décorons notre porcelaine de haute qualité avec le nom ou l'emblème de votre marque, ou encore avec des slogans caractéristiques ou le design de votre choix.

Villeroy & Boch bietet ein umfassendes Gesamtkonzept aus hochwertiger Tischkultur und professionellen „Custom Made Solution“ Services. Perfekt abgestimmt auf Ihre individuellen Ansprüche, dekorieren wir unser hochwertiges Porzellan mit Ihrem Markenzeichen oder Emblem, mit charakteristischen Slogans oder einem von Ihnen ausgewählten Design.

Villeroy & Boch ofrece un concepto global de menaje de mesa de alta calidad y servicios profesionales “Custom Made Solution”. Perfectamente adaptada a sus necesidades individuales, decoramos nuestra porcelana de alta calidad con el nombre o el emblema de su marca, con eslóganes característicos o con un diseño seleccionado por usted.

Villeroy & Boch offre un concetto globale completo di stoviglie di alta qualità e servizi professionali di “Custom Made Solution”. Rispondendo perfettamente alle vostre esigenze individuali, decoriamo la nostra porcellana di alta qualità con il vostro marchio o emblema, con slogan caratteristici o con un design a vostra scelta.



ZAN sushi restaurant (Sweden)



Hotel Bell Rock (Germany)



Venice Simplon-Orient-Express (Italy)

References

Whether haute cuisine, award-winning star-rated cuisine, a trendy local place, a cult bar on the beach or a modern coffee shop – the high-quality tableware from Villeroy & Boch is at home in hotels and restaurants around the world, embodying the highest standards of quality and design based on our professional expertise.

Qu'il s'agisse de haute gastronomie, de cuisine étoilée primée, d'un bistrot branché avec une scène, d'un bar de plage culte ou d'un café moderne, la vaisselle de Villeroy & Boch incarne dans les hôtels et restaurants du monde entier les plus hauts standards de qualité et de design : c'est la meilleure preuve de notre expertise professionnelle.

Ob Haute Cuisine, prämierte Sterneküche, trendiges Szene-Lokal, Kultbar am Strand oder moderner Coffee Shop – Die hochwertige Tischkultur von Villeroy & Boch ist in Hotels und Restaurants rund um die Welt zu Hause und steht für höchste Ansprüche an Qualität und Design und ist der beste Beweis für unsere professionelle Kompetenz.

Ya sea en la alta cocina, restaurantes galardonados, bares de moda, bares de culto en la playa o en modernas cafeterías, el menaje de mesa de alta calidad de Villeroy & Boch se encuentra en hoteles y restaurantes de todo el mundo y representa los máximos estándares de calidad y diseño; asimismo, es la mejor prueba de nuestra competencia profesional.

Che si tratti di alta cucina, della cucina stellata, di locali alla moda, bar famosi sulla spiaggia o moderne caffetterie: i pregiati articoli di Villeroy & Boch sono di casa negli hotel e nei ristoranti di tutto il mondo e rappresentano gli standard più elevati di qualità e design e sono la migliore prova della nostra competenza professionale.



Hotel Bell Rock



L'Opera

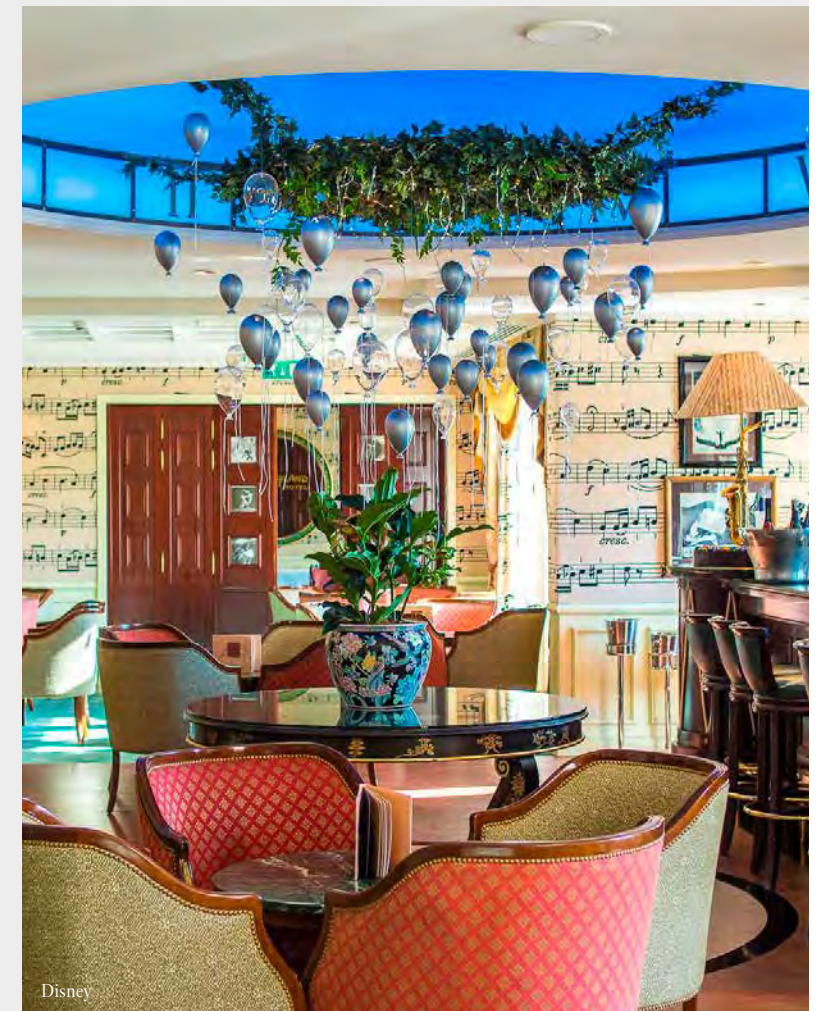

Disney



Premium PORCELAIN

The Villeroy brand stands for impressive designs and breathtaking style statements. We have always created true icons for eternity with our unique tableware. Our high-quality Premium Porcelain range is particularly expressive and diverse - from casual dining to fine dining, from banquets to bar lounges.

La marque Villeroy incarne design impressionnant et déclaration de style à couper le souffle. Depuis toujours, nous créons de véritables icônes pour l'éternité avec nos arts de la table uniques. Notre gamme en Premium Porcelain de haute qualité expressive et polyvalente convient ainsi du repas décontracté au repas raffiné, du banquet au bar lounge.

Die Marke Villeroy steht für eindrucksvolles Design und atemberaubende Stilstatements. Seit jeher haben wir mit unserer einzigartigen Tischkultur wahre Ikonen für die Ewigkeit und geschaffen. Unser hochwertiges Premium Porcelain Sortiment ist besonders ausdrucksstark und vielseitig: von Casual Dining bis Fine Dining, von Bankett bis Bar Lounge.

La marca Villeroy es sinónimo de un diseño impresionante y de un estilo que quita el aliento. Desde siempre, hemos creado verdaderos iconos para la eternidad con nuestro singular menaje de mesa. Nuestra gama de Premium Porcelain de alta calidad es muy expresiva y versátil: desde platos informales a más refinados, desde banquetes a *lounge bar*.

Il marchio Villeroy è sinonimo di design eccezionale e dichiarazioni di stile mozzafiato. Abbiamo sempre creato vere icone destinate a durare per l'eternità. La nostra gamma Premium Porcelain di alta qualità è particolarmente espressiva e versatile: dal casual dining al fine dining, dai banchetti al bar lounge.



RANGE OVERVIEW

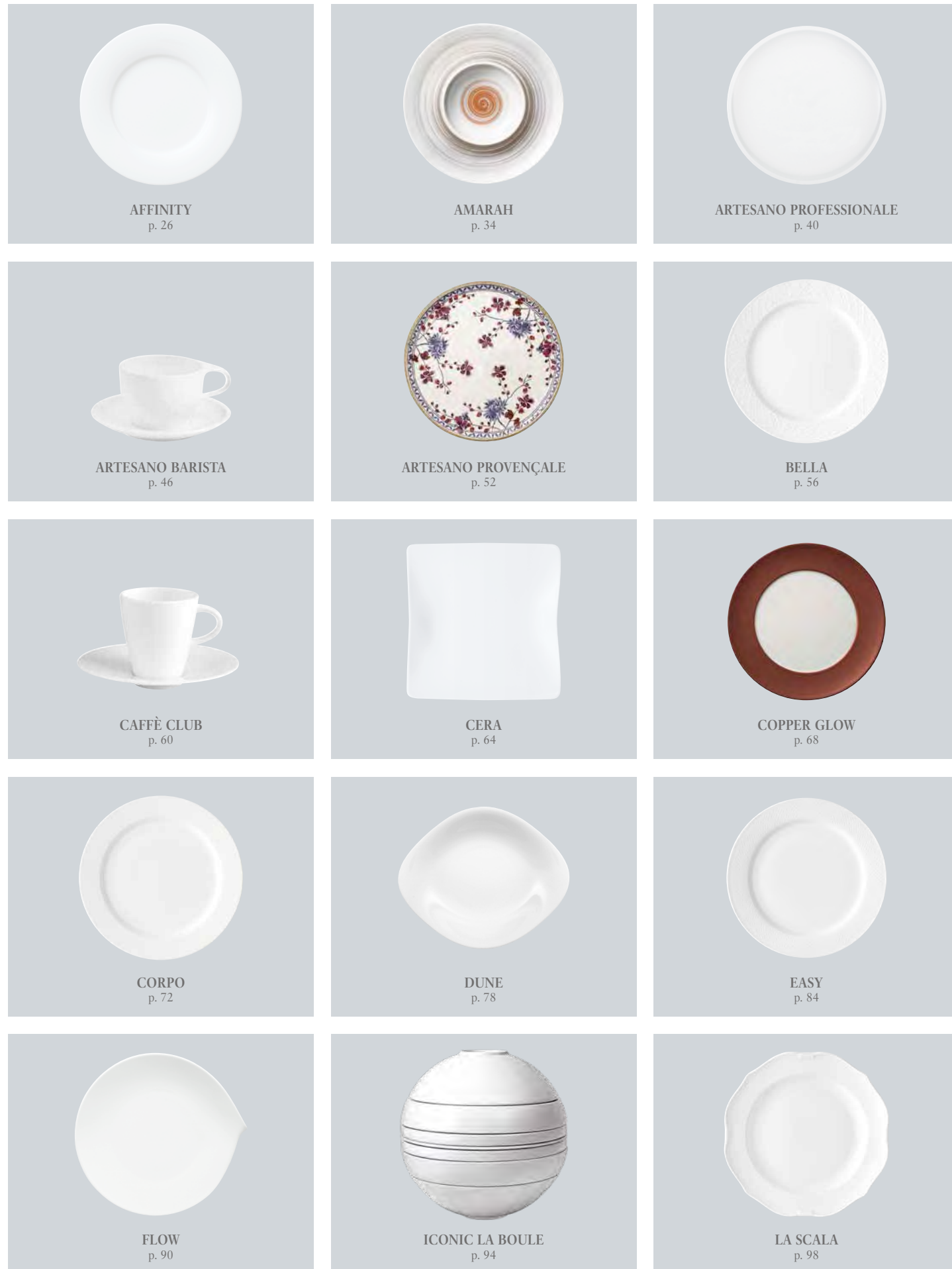

RANGE OVERVIEW

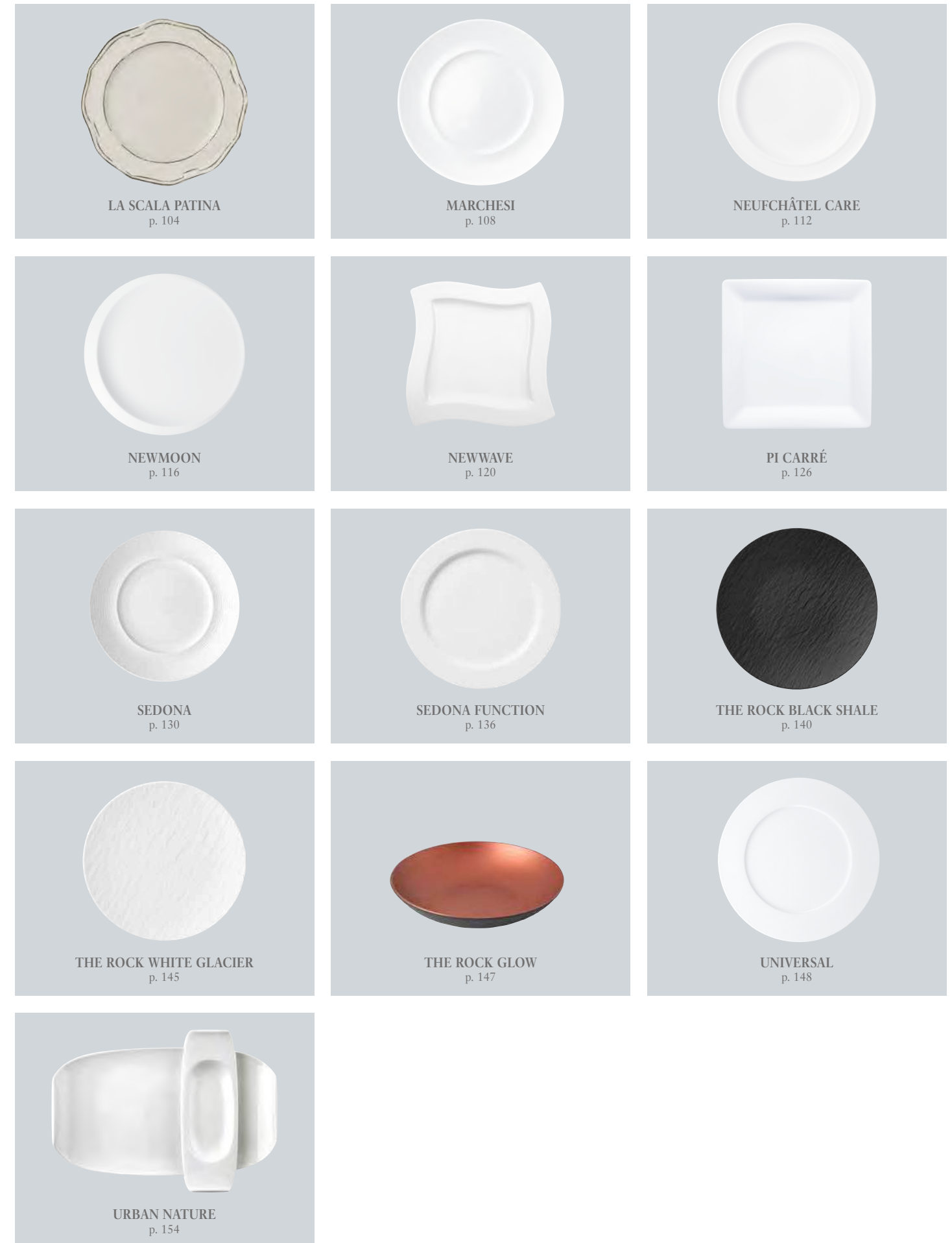



OCR 16-4004-0465
Teapot/Coffee pot w. cover/filter
1,01 | 33½ oz.



OCR 16-4004-0630
Teapot/Coffee pot w. cover/filter
0,41 | 13½ oz.



OCR 16-4004-0780
Creamer
0,251 | 8½ oz.



OCR 16-4004-4895
Mug with handle stackable
0,41 | 13½ oz.



OCR 16-4004-2513
Soup cup stackable
110 mm · 0,341 | 4½" · 11½ oz.



OCR 16-4004-2514
Unhandled soup cup stackable
110 mm · 0,341 | 4½" · 11½ oz.



OCR 16-4004-0800
Creamer/Sauceboat
0,11 | 3½ oz.



OCR 16-4004-0930
Sugar bowl with cover
135 x 65 mm · 0,261 | 5½ x 2½" · 8½ oz.



OCR 16-4004-0950
Cover sugar bowl/Individual bowl
135 x 65 mm | 5½ x 2 ½"



OCR 16-4004-2525
Flat cover
110 mm | 4½"
Ref. 2513, 2514



OCR 16-4004-1250
Saucer
180 mm | 7"
Ref. 1905, 1360, 2513, 2514, 4870, 4895



OCR 16-4004-1280
Saucer
160 mm | 6½"
Ref. 0780, 0800, 1270, 1271, 1450, 1451, 3831, 4910



OCR 16-4004-1270
Cup
0,221 | 7½ oz.



OCR 16-4004-1450
Cup
0,11 | 3½ oz.



OCR 16-4004-1360
Cup
0,251 | 8½ oz.



OCR 16-4004-1460
Saucer
135 mm | 5½"
Ref. 1450, 1451



OCR 16-4004-1311
Rectangular saucer
180 x 160 mm | 7 x 6½"
Ref. 0800, 1270, 1271, 1360, 1905, 2513, 2514, 3831, 4870, 4895, 4910



OCR 16-4004-1431
Rectangular saucer
120 x 110 mm | 4½ x 4½"
Ref. 1450, 1451



OCR 16-4004-4870
Mug with handle
90 mm · 0,41 | 3½" · 13½ oz.



OCR 16-4004-1271
Cup stackable
80 mm · 0,221 | 3½" · 7½ oz.



OCR 16-4004-1451
Cup stackable
60 mm · 0,11 | 2½" · 3½ oz.



OCR 16-4004-2830
Rectangular partyplate
270 x 160 mm | 10½ x 6½"
Ref. 0800, 1270, 1271, 1360, 1905, 2513, 2514, 3831, 4870, 4895, 4910



OCR 16-4004-2831
Rectangular partyplate
180 x 110 mm | 7 x 4½"
Ref. 1450, 1451



OCR 16-4004-1550
Partyplate
280 x 175 mm | 11 x 6½"
Ref. 0220, 0630, 0780, 0800, 1270, 1271, 1360, 1905, 2513, 2514, 3831, 4870, 4895, 4910

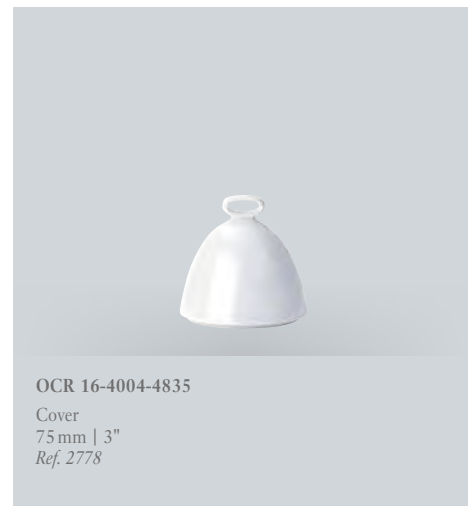
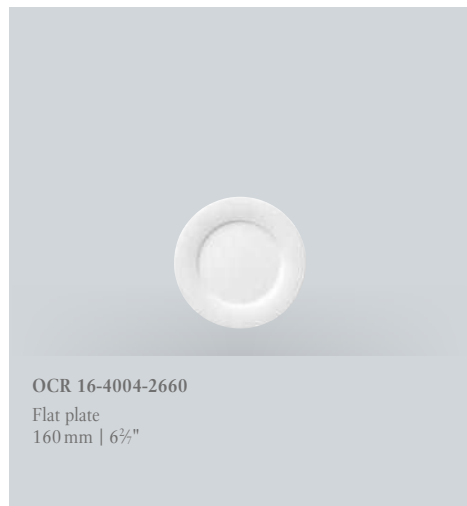





AMARAH

— Collection —

Amarah adds sensuous colours and distinctive artisan simplicity to modern catering. Natural tones in a brushstroke look and earthy structures create an attractive decor, which forms an effective contrast with the simple design.

La collection Amarah scelle l'entrée de couleurs sensuelles et d'un artisanat authentique dans la gastronomie moderne. Ses teintes naturelles comme appliquées au pinceau et ses structures terreuses créent un décor attrayant qui contraste efficacement avec la simplicité du design.

Amarah bringt sinnliche Farben und ursprüngliches Kunsthandwerk in die moderne Gastronomie. Naturtöne in Pinselstrichoptik und erdige Strukturen kreieren ein attraktives Dekor, das einen wirkungsvollen Kontrast zu der schlichten Formensprache bildet.

Amarah lleva a la gastronomía moderna colores sensuales y artesanía original. Los tonos naturales con aspecto de pincelada y las texturas terrosas crean una atractiva decoración que contrasta eficazmente con el sencillo lenguaje del diseño.

Amarah contribuisce con i propri colori sensuali e un gusto artigianale originale alla moderna gastronomia. Tonalità naturali tratteggiate a pennello e strutture terrose creano un design accattivante, che genera un contrasto efficace rispetto alla sobrietà delle linee.





OCR 16-4019-2595
Flat coupe plate
320 mm | 12½"



OCR 16-4019-2661
Flat coupe plate
160 mm | 6½"



OCR 16-4019-2697
Flat gourmet rectangular plate
370 x 250 mm | 14½ x 9"



OCR 16-4021-2795
Flat plate
290 x 145 mm | 11½ x 5½"



OCR 16-4021-2796
Flat plate
290 x 180 mm | 11½ x 7"



OCR 16-4021-2621
Flat coupe plate
290 mm | 11½"



OCR 16-4019-2646
Flat rectangular plate
260 x 200 mm | 10¼ x 7¾"



OCR 16-4019-2660
Flat rectangular plate
180 x 150 mm | 7 x 6"



OCR 16-4019-2596
Flat rectangular antipasti plate
420 x 150 mm | 16½ x 6"



OCR 16-4021-2630
Flat coupe plate
250 mm | 9"



OCR 16-4021-2650
Flat coupe plate
210 mm | 8¼"



OCR 16-4022-1900
Bowl
0,61 | 20½ oz.



OCR 16-4019-1901
Individual bowl
0,351 | 11½ oz.



OCR 16-4020-2595
Flat coupe plate
320 mm | 12½"

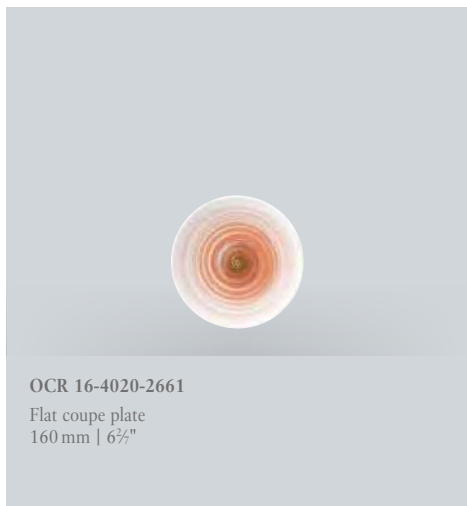

OCR 16-4020-2661
Flat coupe plate
160 mm | 6½"



OCR 16-4022-3933
Dip bowl with handle
0,061 | 2 oz.



OCR 16-4022-1210
Cup
0,391 | 13½ oz.

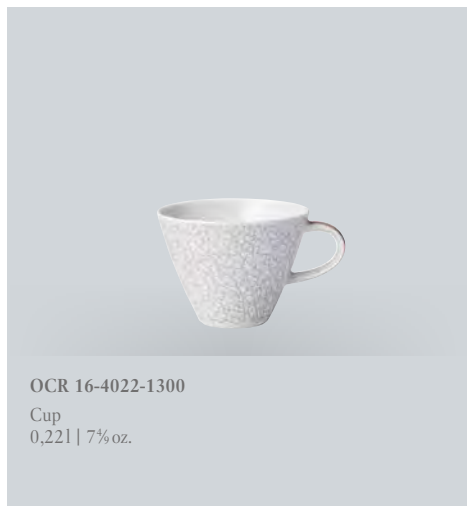

OCR 16-4022-1300
Cup
0,221 | 7½ oz.



OCR 16-4020-2700
Deep plate
290 x 140 mm · 0,321 | 11½ x 5½" · 10½ oz.



OCR 16-4020-2701
Deep coupe plate
290 mm · 0,281 | 11½" · 9½ oz.



OCR 16-4020-3867
Deep bowl
230 mm · 0,61 | 9" · 20½ oz.



OCR 16-4022-1420
Cup
0,11 | 3½ oz.



OCR 16-4021-1220
Saucer
170 mm | 6½"
Ref. 1210



OCR 16-4021-1310
Saucer
140 mm | 5½"
Ref. 1300

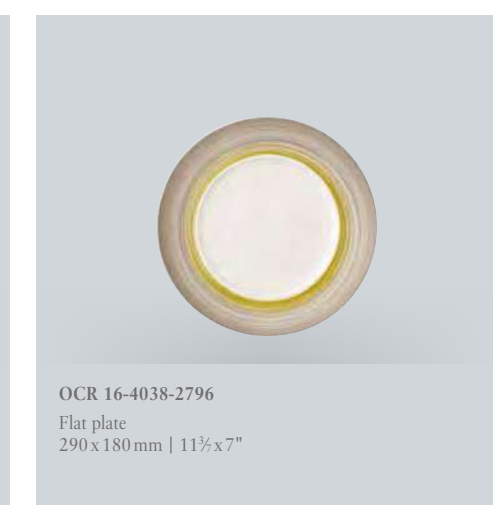
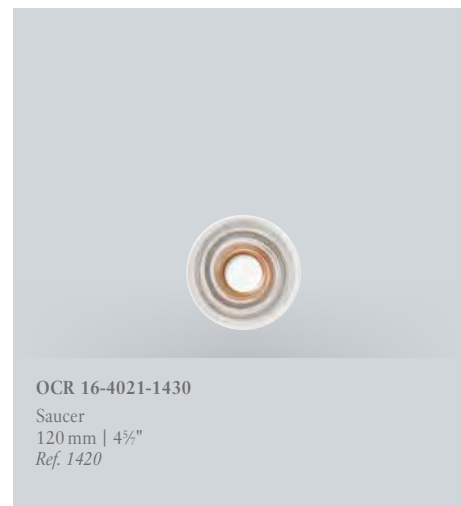



ARTESANO PROFESSIONALE

— Collection —

Artesano Professionale impresses with a clean, authentic design made of the finest Premium Porcelain. The linear design offers the perfect stage for expressive compositions to thrill your guests.

Artesano Professionale séduit par un design net et authentique en Premium Porcelain des plus raffinées. Son design rectiligne offre une toile de fond parfaite pour des compositions expressives qui séduiront vos clients.

Artesano Professionale überzeugt mit einer klaren, authentischen Formensprache aus feinstem Premium Porcelain. Das geradlinige Design bietet die perfekte Bühne für ausdrucksvolle Kompositionen, um Ihre Gäste zu begeistern.

Artesano Professionale convence con un lenguaje de diseño claro y auténtico hecho realidad con la mejor Premium Porcelain. El diseño rectilíneo ofrece el escenario perfecto para que las composiciones expresivas inspiren a sus invitados.

ArtesanoProfessionale colpisce per un linguaggio formale chiaro e autentico realizzato in finissima Premium Porcelain. Il design lineare offre il palcoscenico perfetto per composizioni espressive che entusiasmeranno i vostri ospiti.

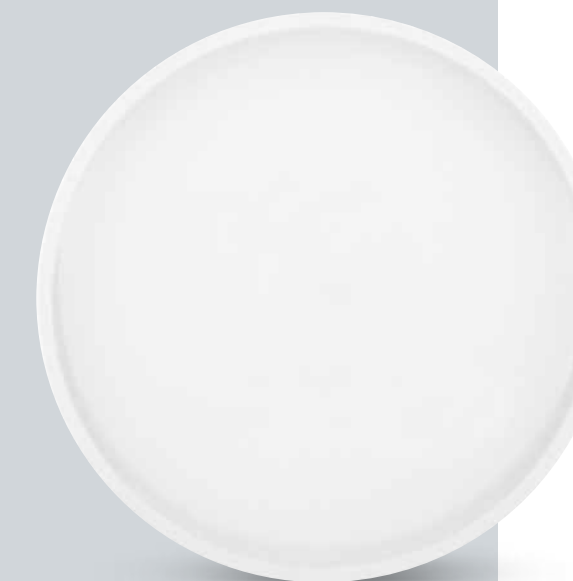

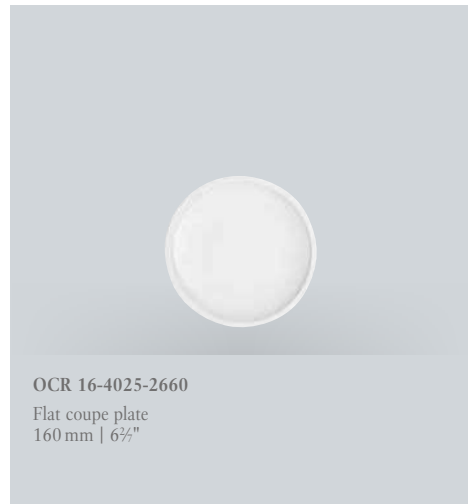
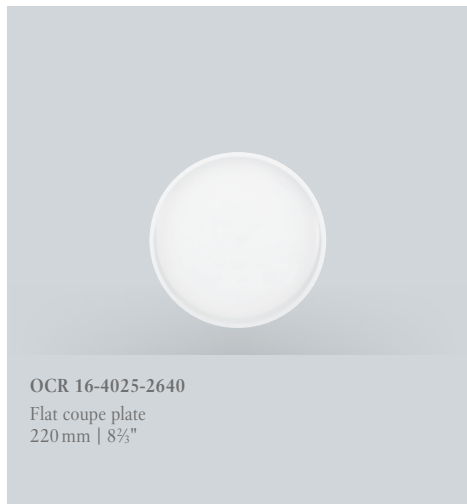
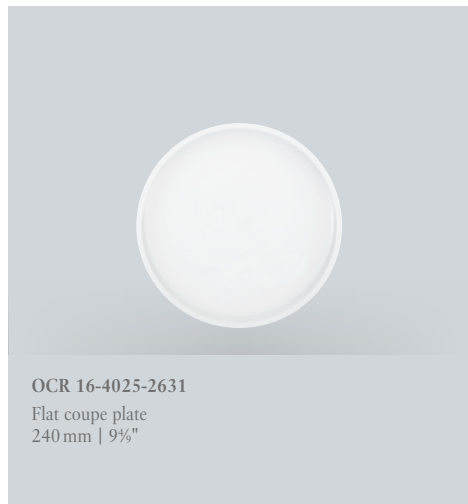
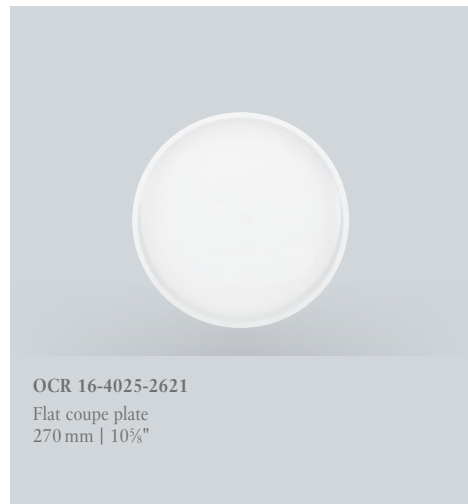

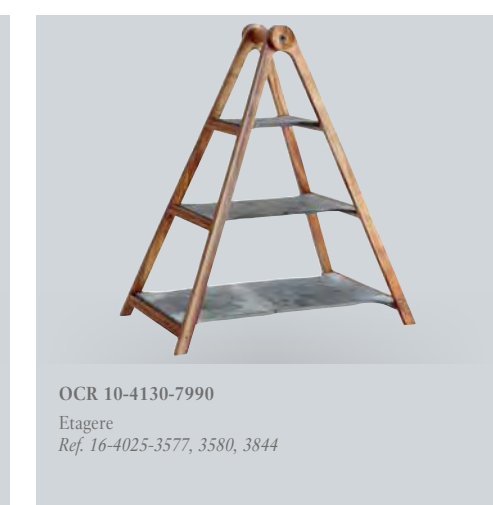
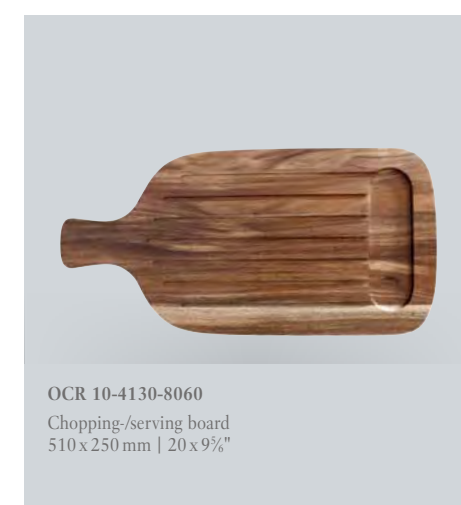
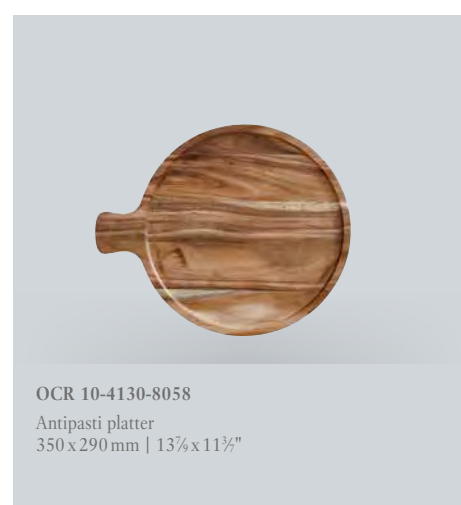
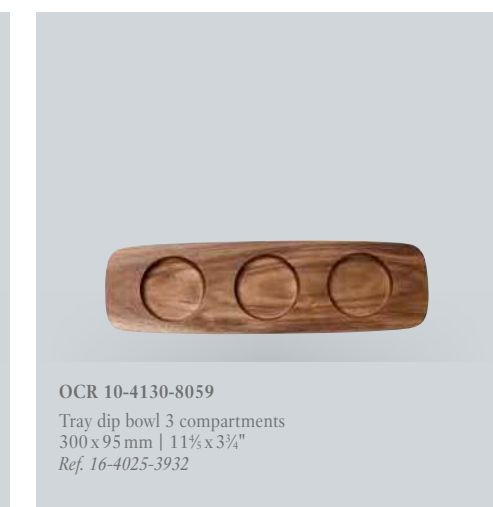



ARTESANO BARISTA

Collection

Artesano impresses with a clean, authentic design and a unique mix of the finest Premium Porcelain and high-quality glass. The linear design fits seamlessly into different restaurant concepts with its multifunctional items.

Artesano séduit par son esthétique nette et authentique et par un mélange unique de matériaux composé de la Premium Porcelain des plus raffinées et de verre de haute qualité. Son design rectiligne se fond harmonieusement dans une grande variété de concepts de restauration grâce à ses articles multifonctionnels.

Artesano überzeugt mit einer klaren, authentischen Formensprache sowie einem einzigartigen Materialmix aus feinstem Premium Porcelain und hochwertigem Glas. Das geradlinige Design fügt sich mit seinen multifunktional einsetzbaren Artikeln harmonisch in die verschiedensten Restaurantkonzepte ein.

Artesano destaca con un lenguaje de formas claro y auténtico y una mezcla de materiales única de la mejor Premium Porcelain y vidrio de alta calidad. El diseño rectilíneo, con sus elementos multifuncionales, se integra armoniosamente en una gran variedad de conceptos de restauración.

Artesano convince per un linguaggio formale chiaro e autentico nonché per un mix unico di materiali fatto di finissima Premium Porcelain e vetro di alta qualità. Il design lineare, con i suoi articoli multifunzionali, si inserisce armoniosamente nei più svariati concetti di ristorazione.



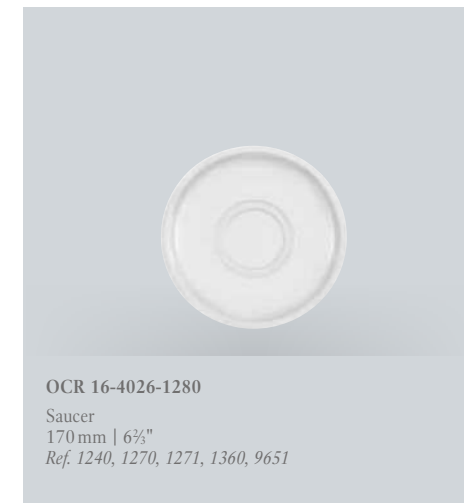
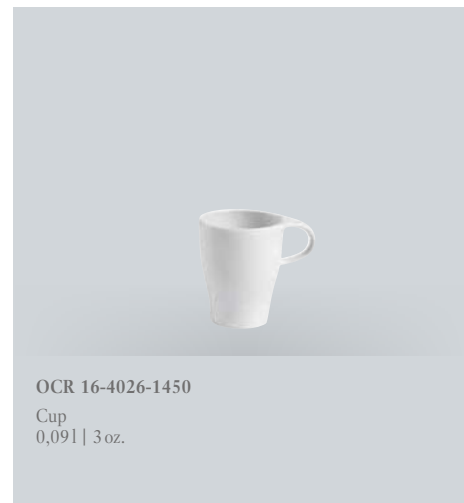
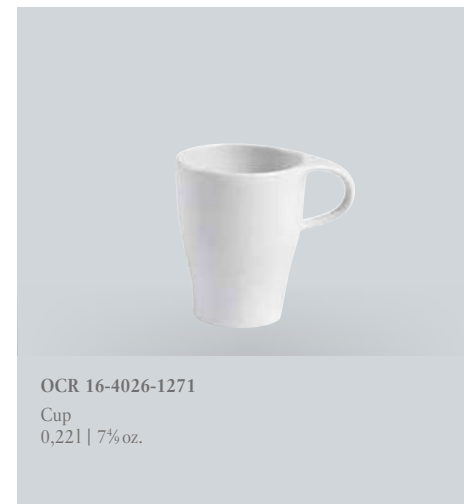
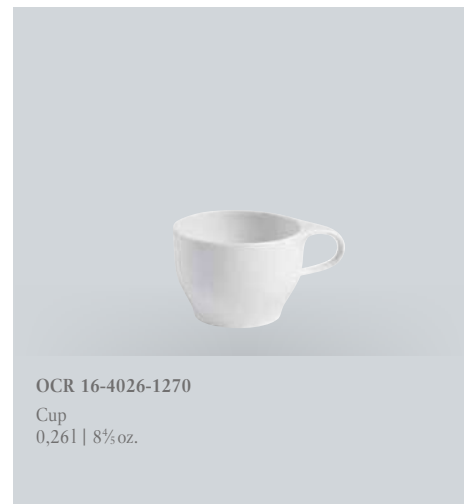
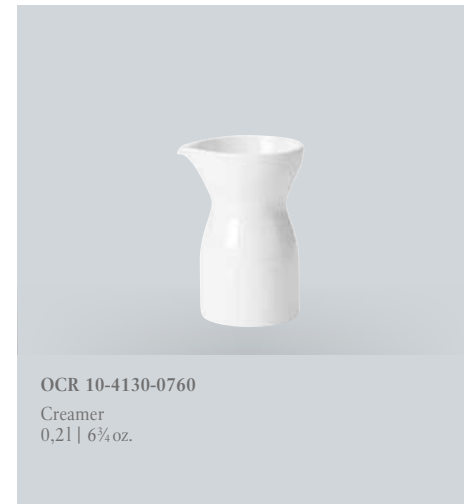

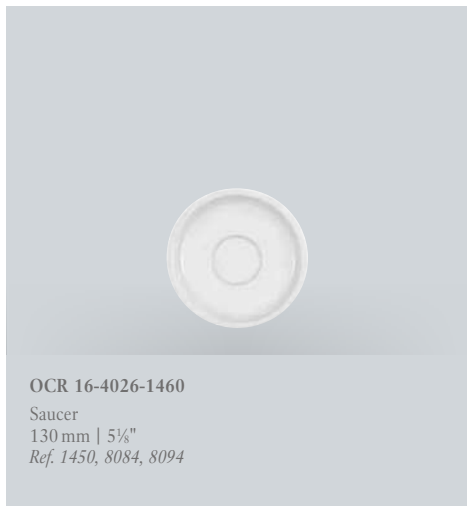



ARTESANO PROVENÇALE

— Collection —

The charming floral decor of Artesano Provençal enchants with a delicate violet border, reminiscent of fascinating lavender blossoms in Provence, exuding a Mediterranean, French flair on any table setting.

Le charmant décor floral d'Artesano Provençale enchante par sa délicate bordure violette qui rappelle la fascinante fleur de lavande de Provence et donne à la table une allure méditerranéenne et française.

Das charmant florale Dekor von Artesano Provençale verzaubert mit einer zarten, violetten Bordüre, die an die faszinierende Lavendelblüte der Provence erinnert und versprüht somit mediterranes, französisches Flair auf der gedeckten Tafel.

La encantadora decoración floral de Artesano Provençale deleita con un delicado borde violeta que recuerda a la fascinante flor de lavanda de la Provenza y, por tanto, desprende un aire mediterráneo y francés en la mesa.

L'affascinante decoro floreale di Artesano Provençale incanta con un delicato bordo viola che ricorda gli affascinanti fiori di lavanda della Provenza e quindi diffonde un tocco mediterraneo e francese sulla tavola.



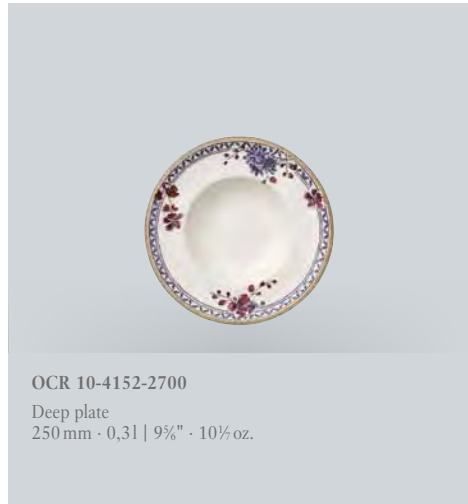
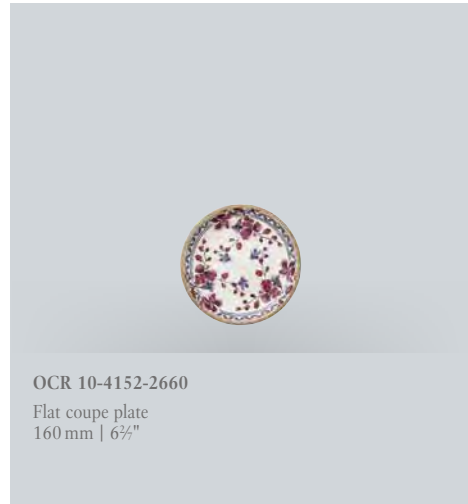



BELLA

— Collection —

The Bella dinnerware series brings stylish accents to the table and is reminiscent of an expressive basket relief, which blends seamlessly into traditional restaurant settings, yet is equally at home in the world of fine dining and haute cuisine.

La série de vaisselle Bella apporte des notes élégantes sur la table dressée et séduit par son relief expressif en forme de panier qui se fond harmonieusement aussi bien dans la gastronomie traditionnelle que dans une cuisine particulièrement audacieuse et haut de gamme.

Die Geschirrsreihe Bella setzt stilvolle Akzente auf der gedeckten Tafel und begeistert mit einem ausdrucksstarken Basket Relief, das sich sowohl in der traditionellen Gastronomie als auch in der besonders ambitionierten und gehobenen Cuisine harmonisch einfügt.

La vajilla Bella aporta toques de estilo en la mesa y deleita con un expresivo relieve en forma de cesta que se integra en equilibrio tanto en la gastronomía tradicional como en la cocina ambiciosa y de alto nivel.

La serie di stoviglie Bella pone degli accenti di stile sulla tavola apparecchiata e ispira con un espressivo rilievo a cesto che si inserisce armoniosamente nella gastronomia tradizionale e nella cucina particolarmente ambiziosa e sofisticata.





OCR 16-2238-1100
Rectangular sugar bowl
100 mm · 0,221 | 4" · 7%oz.



OCR 16-2238-1270
Cup N.2
0,221 | 7%oz.



OCR 16-2238-1450
Cup N.8
0,11 | 3%oz.



OCR 16-2238-2630
Flat plate
240 mm | 9"



OCR 16-2238-2640
Flat plate
210 mm | 8"



OCR 16-2238-2660
Flat plate
160 mm | 6"



OCR 16-2238-1271
Cup N.2 stackable
0,221 | 7%oz.



OCR 16-2238-1361
Cup N.4 stackable
0,181 | 6oz.



OCR 16-2238-1451
Cup N.8 stackable
0,11 | 3%oz.



OCR 16-2238-3010
Deep plate
290 mm · 0,651 | 11½" · 22 oz.



OCR 16-2238-2700
Deep plate
230 mm · 0,451 | 9" · 15%oz.



OCR 16-2238-2720
Oval flat plate
320 x 240 mm | 12½ x 9"



OCR 16-2238-2513
Soup cup stackable
0,261 | 8%oz.



OCR 16-2238-2514
Unhandled soup cup stackable
0,261 | 8%oz.



OCR 16-2238-1280
Saucer
150 mm | 6"
Ref. 1270, 1271, 1361, 2513, 2514



OCR 16-2238-3570
Oval pickle dish
210 x 170 mm | 8¼ x 6½"



OCR 16-2238-2800
Flat plate
320 mm | 12½"



OCR 16-2238-1900
Bowl
0,751 | 25%oz.



OCR 16-2238-1460
Saucer
120 mm | 4½"
Ref. 1450, 1451



OCR 16-2238-2600
Flat plate
290 mm | 11½"



OCR 16-2238-2620
Flat plate
270 mm | 10½"



OCR 16-2238-3930
Individual bowl N.3
120 mm · 0,151 | 4½" · 5 oz.



CAFFÈ CLUB

Collection

The timeless design of Caffè Club meets the highest standards for holistic coffee enjoyment. Whether espresso, cappuccino or coffee with cream – the stylish cups showcase any coffee speciality to perfection. Your baristas can be as creative as they like.

Le design intemporel de Caffè Club répond aux exigences les plus élevées en termes de dégustation du café. Qu'il s'agisse d'espresso, de cappuccino ou de café crème, ces jolies tasses mettent parfaitement en scène chaque spécialité de café. La créativité de votre barista ne connaîtra ainsi aucune limite.

Das zeitlose Design von Caffè Club erfüllt höchste Ansprüche an einen vollendeten Kaffeegenuss. Ob Espresso, Cappuccino oder Crema – die formschönen Tassen setzen jede Kaffeespezialität perfekt in Szene. Ihrem Barista sind keine Grenzen gesetzt.

El diseño atemporal de Caffè Club cumple con las más altas exigencias para disfrutar de un café perfecto. Ya se trate de un expreso, un capuchino o un crema, sus bellas tazas sacan lo mejor de cada especialidad. Plena libertad creativa para servir.

Il design sempre attuale di Caffè Club soddisfa le massime esigenze per godersi appieno il piacere del caffè. Che si tratti di espresso, cappuccino o caffè macchiato, le bellissime tazze sapranno mettere in risalto qualsiasi specialità. Non ci sono limiti per il vostro barista.







CERA

— Collection —

Cera delights with an extraordinary and varied design. The interplay of square, rectangular and round shapes and a spirited wave character creates a powerful and eye-catching design.

La collection Cera séduit par son design exceptionnel et varié. Le jeu des formes carrées, rectangulaires et rondes, ainsi que les ondulations de l'ensemble créent un design affirmé qui attire tous les regards.

Die Kollektion Cera begeistert mit einer außergewöhnlichen, abwechslungsreichen Formensprache. Das Zusammenspiel aus quadratischen, rechteckigen und runden Formen und einem schwungvollen Wellencharakter kreiert einen designstarken Eyecatcher.

La colección Cera inspira con un lenguaje de diseño extraordinario y variado. El juego de formas cuadradas, rectangulares y redondas y el carácter dinámico de las ondas crean un diseño llamativo.

La collezione Cera conquista con un linguaggio di design straordinario e variegato. L'interazione di forme quadrate, rettangolari e rotonde e un vivace carattere ondulato crea dei protagonisti ricchi di stile.







COPPER GLOW

Collection

Copper Glow brings you hand-painted artistry on every item. Whether flat, applied like a ribbon over the rim or centred – the result is a delicate “swirl structure” with an aesthetic that is hand-crafted and bold. Thanks to the fine copper lustre, Copper Glow is a star in the world of fine dining; a veritable byword for the art of gourmet indulgence.

Chaque pièce Copper Glow est un chef d’œuvre unique peint à la main. Sur toute la surface de l’assiette ou juste sur les ailes ou le fond, son décor dessine un tourbillon délicat, au caractère affirmé et artisanal. Avec son éclat cuivré raffiné, Copper Glow est un incontournable du style Fine Dining et incarne l’art suprême de la gastronomie.

Copper Glow ist handgemalte Kunst auf jedem Teil. Flächig, als Fahne bis über den Rand oder zentriert – es entsteht eine feine „Swirl-Struktur“ mit akzentuiertem und zugleich handwerklichem Charakter. Dank des edlen Kupferglanzes avanciert Copper Glow zu einem Star in der Fine Dining Szene und steht für die hohe Kunst des Gourmet-Genuss.

Copper Glow es puro arte pintado a mano. Los platos son amplios y están centrados o dispuestos como un estandarte que se extiende hasta el borde; su textura en espiral es exquisita y posee un carácter artesanal. El brillo elegante del cobre convierte a Copper Glow en la estrella del *Fine Dining* y en representante del arte de la cocina *gourmet*.

Ogni pezzo della serie Copper Glow è dipinto a mano. Sull’intera superficie si viene a creare una raffinata “struttura a spirale” di grande effetto. Grazie alla brillantezza del rame, Copper Glow è la star della scena Fine Dining, grazie a uno stile esclusivo che incarna la più elevata forma d’arte al servizio dei piaceri del palato.



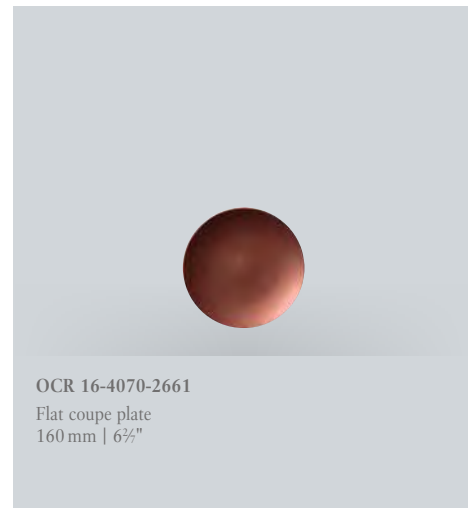

Cover Seal by Villeroy & Boch is the new metallic-effect surface finish – durable, dishwasher-safe, microwave-safe and salamander-safe.



CORPO

— Collection —

Corpo is a true all-rounder that, thanks to the simple classic design, is extremely versatile in terms of presentation and combinations. From breakfast to classic casual dining - the clean lines and the pure white decor on fine Premium Porcelain harmonise in any situation.

Corpo est une véritable collection polyvalente qui peut être mise en scène et combinée de diverses manières grâce à son design simple et classique. Du petit-déjeuner au repas décontracté classique, ses lignes nettes et son décor blanc épuré ornant une Premium Porcelain raffinée conviennent à toutes les situations.

Corpo ist ein wahrer Allrounder, der sich dank des schlichten, klassischen Designs vielfältig inszenieren und kombinieren lässt. Vom Frühstück bis zum klassischen Casual Dining - Die klare Linienführung und das puristisch weiße Dekor auf feinem Premium Porcelain harmonieren in jeder Situation.

Corpo es una colección verdaderamente versátil que se puede usar y combinar de diversas maneras gracias a su diseño sencillo y clásico. Desde el desayuno hasta una clásica cena informal, las líneas claras y la decoración de color blanco purista sobre Premium Porcelain se combinan bien en cualquier situación.

Corpo è un vero campione di versatilità, può essere messo in scena e combinato in vari modi grazie al suo design semplice e classico. Dalla colazione al classico pranzo informale: le linee chiare e il decoro bianco candido su fine Premium Porcelain si integrano al meglio in ogni situazione.

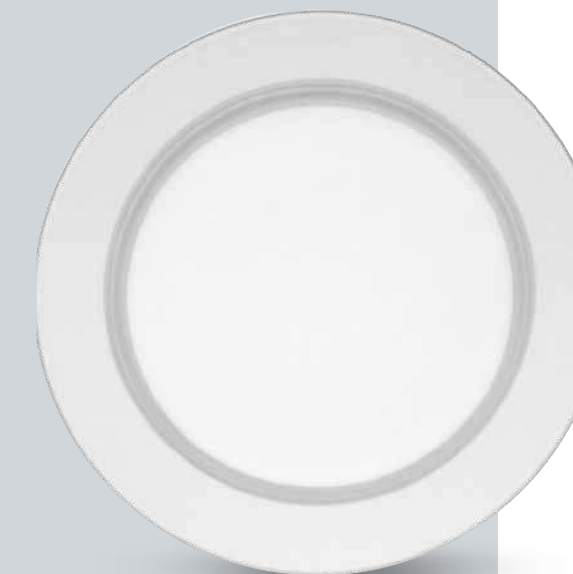



OCR 16-2016-0130
Coffeepot N.4 with cover
0,71 | 23½ oz.



OCR 16-2016-0220
Coffeepot N.7 with cover
0,31 | 10½ oz.



OCR 16-2016-0530
Teapot N.5 with cover
0,41 | 13½ oz.



OCR 16-2016-1270
Cup N.2
0,221 | 7% oz.



OCR 16-2016-1450
Cup N.8
0,11 | 3% oz.



OCR 16-2016-4870
Mug with handle
0,31 | 10½ oz.



OCR 16-2016-1271
Cup N.2 stackable
0,221 | 7% oz.



OCR 16-2016-1361
Cup N.4 stackable
0,181 | 6 oz.



OCR 16-2016-1451
Cup N.8 stackable
0,11 | 3% oz.



OCR 16-2016-2510
Soup cup
0,271 | 9% oz.



OCR 16-2016-1280
Saucer
150 mm | 6"
Ref. 1270, 1271, 1361, 2510, 4870 und 16-2040-1710,
2513, 2514



OCR 16-2016-1460
Saucer
120 mm | 4½"
Ref. 1450, 1451

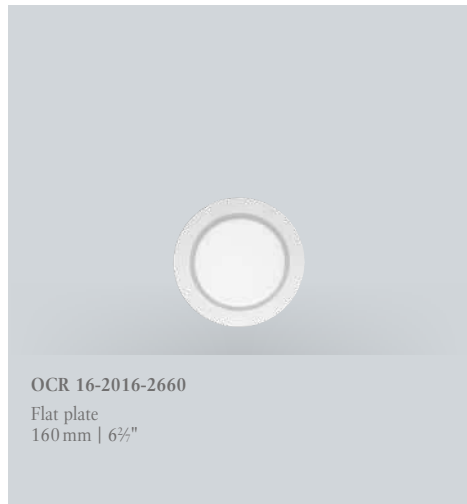
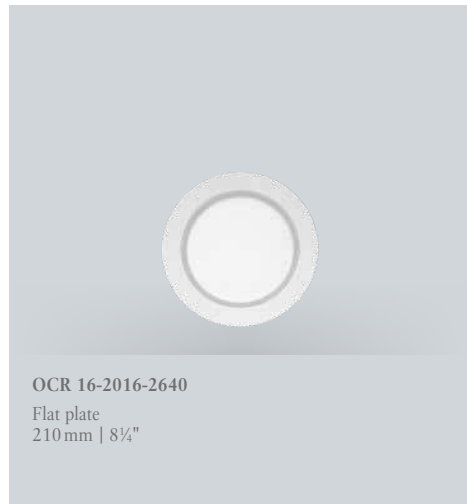
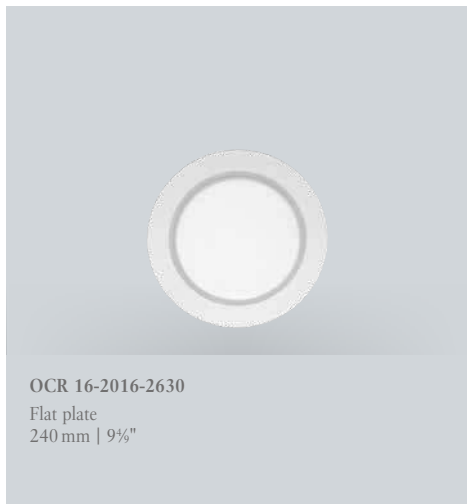



DUNE

— Collection —

Dune's organic shape was inspired by the cool silhouette of sand dunes shaped by desert winds. The exceptional design brings some Italian flair to the table setting and is therefore perfect for serving pasta, pizza or salad creations in style.

Les formes organiques de Dune s'inspirent de l'audacieux relief de dunes modelées par le vent. Son design exceptionnel crée un style italien sur la table et est donc parfait pour servir des pâtes, des pizzas ou des salades avec style.

Die organische Form von Dune ist angelehnt an die kühne Silhouette vom Wind geformter Dünenkämme. Das außergewöhnliche Design zaubert ein italienisches Flair auf die gedeckte Tafel und ist somit perfekt dazu geeignet, Pasta-, Pizza- oder Salatkreationen stilvoll zu servieren.

Las formas orgánicas de Dune están basadas en la llamativa silueta de las dunas esculpidas por el viento. El inusual diseño evoca encanto italiano en la mesa y, por lo tanto, es perfecto para servir creaciones de pasta, pizza o ensalada con estilo.

La forma organica di Dune si ispira all'audace sagoma delle dune modellate dal vento. Lo straordinario design evoca un tocco italiano sulla tavola apparecchiata ed è quindi perfetto per servire con stile piatti di pasta, pizza o insalate.





OCR 16-3293-0220
Coffeepot N.7 with cover
0,31 | 10½ oz.



OCR 16-3293-0530
Teapot N.5 with cover
0,41 | 13½ oz.



OCR 16-3293-0800
Creamer N.6
0,151 | 5 oz.



OCR 16-3293-9651
Mug with handle
0,41 | 13½ oz.



OCR 16-3293-1250
Saucer
190 mm | 7½"
Ref. 1240



OCR 16-3293-1280
Saucer
160 mm | 6¼"
Ref. 1270, 1271, 1300, 1360, 1361



OCR 16-3293-0930
Sugar bowl with cover
0,161 | 5½ oz.



OCR 16-3293-1240
Cup
0,41 | 13½ oz.



OCR 16-3293-1300
Cup
0,261 | 8½ oz.



OCR 16-3293-1460
Saucer
130 mm | 5"
Ref. 1450, 1451



OCR 16-3293-2590
Flat plate
320 mm | 12½"



OCR 16-3293-2600
Flat plate
290 mm | 11½"



OCR 16-3293-1270
Cup N.2
0,221 | 7½ oz.



OCR 16-3293-1360
Cup N.4
0,181 | 6 oz.



OCR 16-3293-1450
Cup N.8
0,081 | 2½ oz.



OCR 16-3293-2610
Flat plate
270 mm | 10½"



OCR 16-3293-2655
Flat plate
185 mm | 7½"



OCR 16-3293-2660
Flat plate
160 mm | 6¼"



OCR 16-3293-1271
Cup N.2 stackable
0,221 | 7½ oz.



OCR 16-3293-1361
Cup N.4 stackable
0,181 | 6 oz.



OCR 16-3293-1451
Cup N.8 stackable
0,081 | 2½ oz.



OCR 16-3293-2594
Pizza plate
340 mm | 13½"

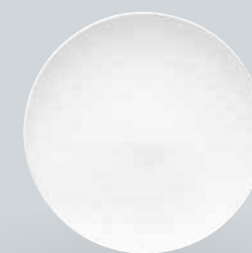

OCR 16-3293-2595
Flat coupe plate
320 mm | 12½"

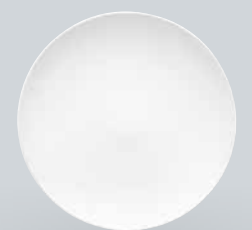

OCR 16-3293-2621
Flat coupe plate
290 mm | 11½"



OCR 16-3293-2630
Flat coupe plate
250 mm | 9 7/8"



OCR 16-3293-2650
Flat coupe plate
210 mm | 8 1/4"



OCR 16-3293-2661
Flat coupe plate
160 mm | 6 1/2"



OCR 16-3293-3881
Flat individual bowl
140 x 110 mm · 0,081 | 5 1/2 x 4 1/2" · 2 3/4 oz.



OCR 16-3293-3970
Butter plate
100 mm · 0,11 | 4" · 3 3/4 oz.



OCR 16-3293-3470
Salt shaker
75 mm | 3"



OCR 16-3293-2720
Oval flat plate
360 x 250 mm | 14 1/4 x 9 7/8"



OCR 16-3293-2730
Oval flat plate
260 x 210 mm | 10 1/4 x 8 1/4"



OCR 16-3293-2535
Soup bowl
180 x 160 mm · 0,71 | 7 x 6 1/2" · 23 3/4 oz.



OCR 16-3293-3480
Pepper shaker
75 mm | 3"



OCR 16-3293-3865
Deep bowl
310 x 240 mm · 0,351 | 12 1/2 x 9 3/4" · 11 1/2 oz.



OCR 16-3293-3866
Deep bowl
270 x 210 mm · 0,81 | 10 5/8 x 8 1/4" · 27 oz.



OCR 16-3293-3867
Deep bowl
210 x 170 mm · 0,81 | 8 1/4 x 6 3/4" · 27 oz.



OCR 16-3293-3905
Individual bowl N.1
150 x 130 mm · 0,41 | 6 x 5 1/8" · 13 1/2 oz.



OCR 16-3293-3906
Individual bowl N.3
120 x 100 mm · 0,251 | 4 7/8 x 4" · 8 oz.



OCR 16-3293-3925
Small individual bowl
70 x 50 mm · 0,031 | 2 3/4 x 2" · 1 oz.





EASY

- Collection -

Modern, light and simple: The Easy dinnerware series impresses with a subtle, minimalistic relief design on perfectly formed Premium Porcelain. Thanks to the reduced, simple look, Easy is universally applicable and can be stylishly combined.

Moderne, légère et simple : la série de vaisselle Easy séduit par son design discret et minimaliste en relief sur une Premium Porcelain de forme parfaite. Grâce à son aspect épuré et simple, Easy convient pour une utilisation universelle et peut être combinée avec style.

Modern, leicht und unkompliziert: Die Geschirrsreihe Easy besticht durch ein dezentes, minimalistisches Relief-Design auf formvollendetem Premium Porcelain. Dank des reduzierten, schlichten Looks ist Easy universell einsetzbar und lässt sich stilvoll kombinieren.

Moderna, ligera y sencilla: la vajilla Easy impresiona con un discreto y minimalista diseño en relieve sobre Premium Porcelain perfectamente moldeado. Gracias a su aspecto reducido y sencillo, Easy puede usarse universalmente y combinarse con estilo.

Moderna, leggera e semplice: La serie di stoviglie Easy convince per il suo design in rilievo sobrio e minimalista su eccezionale Premium Porcelain. Grazie al suo aspetto minimale e semplice, Easy è utilizzabile in modo universale e può essere combinata con stile.



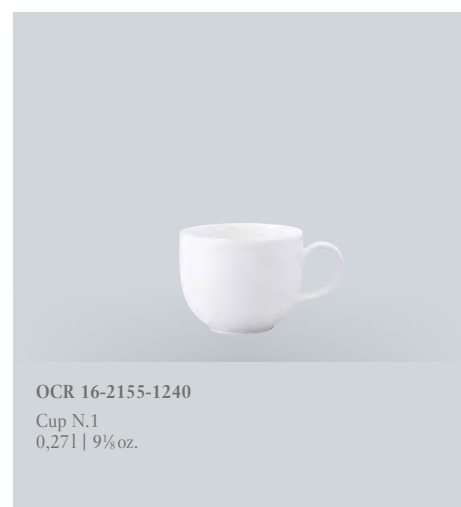

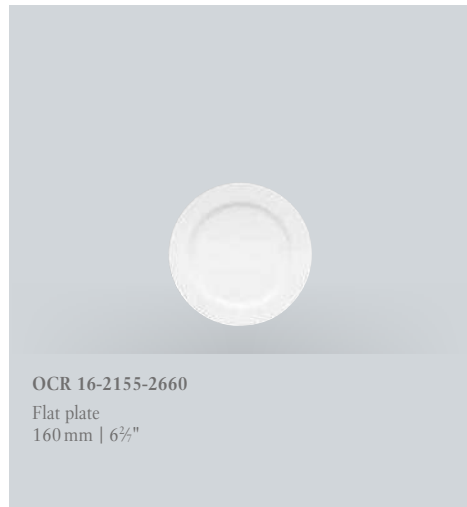



FLOW

— Collection —

Flow impresses with a trendy, organic design, which is ideal for exceptional, creative settings and impressive arrangements. Artful, inspiring combinations can be created both for design-savvy, modern restaurants as well as for the à la carte menu.

Flow séduit par son esthétique organique et tendance, qui convient parfaitement aux cadres exceptionnels et créatifs et aux réalisations impressionnantes. Il en résulte des compositions artistiques et inspirantes, tant pour des restaurants modernes et design que pour un menu à la carte.

Flow überzeugt mit einer trendigen, organischen Formensprache, die sich hervorragend für außergewöhnliche, kreative Settings und eindrucksvolle Arrangements eignet. Sowohl für designaffine, moderne Restaurants als auch für das Menü à la carte ergeben sich kunstvolle, inspirierende Kompositionen.

Flow destaca con un lenguaje de diseño moderno y orgánico que se adapta perfectamente a entornos inusuales y creativos y a arreglos impresionantes. El resultado son composiciones artísticas e inspiradoras tanto para los restaurantes modernos de diseño como para menús a la carta.

Flow convince con un linguaggio formale organico e alla moda, ideale per ambienti originali e creativi come pure per composizioni di grande effetto. Il risultato sono composizioni ingegnose e stimolanti sia per ristoranti moderni e orientati al design, sia per il menu à la carte.





OCR 10-3420-1240
Cup
0,38l | 12½ oz.



OCR 10-3420-1300
Cup
0,2l | 6¾ oz.



OCR 10-3420-1420
Cup
0,1l | 3½ oz.



OCR 10-3420-2775
Flat gourmet plate
310 x 290 mm | 12½ x 11½"

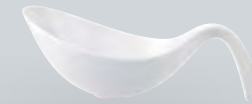

OCR 10-3420-3230
Deep bowl with handle
430 x 260 mm · 1,8l | 17 x 10¼" · 60½ oz.



OCR 10-3420-1925
Bowl with handle
0,6l | 20½ oz.



OCR 10-3420-9651
Mug with handle
0,34l | 11½ oz.



OCR 10-3420-1250
Saucer
210 x 180 mm | 8¼ x 7"
Ref. 1240, 3400



OCR 10-3420-1310
Saucer
180 x 150 mm | 7 x 6"
Ref. 1300, 9651



OCR 10-3420-2940
Oval platter
470 x 290 mm | 18½ x 11½"



OCR 10-3420-2960
Oval platter
360 x 240 mm | 14¼ x 9½"



OCR 10-3420-2535
Bowl
210 x 200 mm · 0,3l | 8¼ x 7¾" · 10½ oz.



OCR 10-3420-1430
Saucer
140 x 120 mm | 5½ x 4½"
Ref. 1420



OCR 10-3420-2620
Flat plate
280 x 270 mm | 11 x 10½"



OCR 10-3420-2610
Flat plate
260 x 240 mm | 10¼ x 9½"



OCR 10-3420-4880
Bowl with handle
190 x 120 mm · 0,45l | 7½ x 4¾" · 15½ oz.



OCR 10-3420-3170
Salad bowl
250 mm · 2,5l | 9½" · 84½ oz.



OCR 10-3420-3180
Salad bowl
210 mm · 1,7l | 8¼" · 57½ oz.



OCR 10-3420-2640
Flat plate
230 x 220 mm | 9 x 8½"



OCR 10-3420-2660
Flat plate
200 x 170 mm | 7¾ x 6½"



OCR 10-3420-2790
Pasta plate
300 x 200 mm · 0,8l | 11½ x 7¾" · 27 oz.



OCR 10-3420-3595
Amuse-bouche with handle
120 x 70 mm · 0,03l | 4½ x 2¾" · 1 oz.



OCR 10-3420-3810
Individual bowl
160 x 130 mm · 0,3l | 6½ x 5½" · 10½ oz.



OCR 10-3420-3400
Sauceboat/soup cup
200 x 130 mm · 0,36l | 7¾ x 5½" · 12½ oz.



ICONIC LA BOULE

Collection

Breathtaking design combined with fascinating functionality: seven stackable tableware elements fit together seamlessly into one artistic design object, offering the ideal culinary stage for culinary creations from talented top chefs.

L'alliance d'un design à couper le souffle et d'une fonctionnalité fascinante : sept éléments de vaisselle empilables se réunissent pour former un objet de design artistique et constituent en même temps la toile de fond culinaire idéale pour les créations de grands chefs talentueux.

Atemberaubendes Design vereint mit faszinierender Funktionalität: Sieben ineinander stapelbare Geschirrelemente fügen sich zu einem kunstvollen Designobjekt zusammen und bieten zugleich die ideale kulinarische Bühne für kulinarische Kreationen talentierter Spitzenköche.

Un diseño impresionante combinado con una funcionalidad que fascina: siete elementos de vajilla apilables se unen para formar un objeto de diseño artístico y, al mismo tiempo, proporcionan el escenario culinario ideal para las creaciones gastronómicas de los mejores chefs.

Design mozzafiato combinato con un'affascinante funzionalità: Sette tipi di stoviglie impilabili l'uno nell'altro si uniscono per formare un oggetto di design artistico e allo stesso tempo offrono il palcoscenico culinario ideale per le creazioni dei migliori chef di talento.



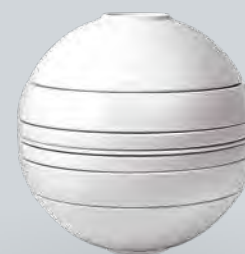

OCR 10-1665-9080
La Boule white



OCR 10-1665-9094
La Boule black



OCR 10-1665-9095
La Boule black & white



OCR 10-1665-6001
Bowl white
215 x 65 mm · 1,11 | 8½ x 2½" · 37½ oz.



OCR 10-1665-6002
Bowl flat white
240 x 40 mm · 1,11 | 9½ x 1½" · 37½ oz.



OCR 10-1665-6003
Universal plate white
240 x 20 mm | 9½ x ¾"



OCR 10-1665-6004
Serving plate white
240 x 15 mm | 9½ x ¾"



OCR 10-1665-6005
Bowl black
215 x 65 mm · 1,11 | 8½ x 2½" · 37½ oz.



OCR 10-1665-6006
Bowl flat black
240 x 40 mm · 1,11 | 9½ x 1½" · 37½ oz.



OCR 10-1665-6007
Universal plate black
240 x 20 mm | 9½ x ¾"



OCR 10-1665-6008
Serving plate black
240 x 15 mm | 9½ x ¾"



LA SCALA

— Collection —

The La Scala collection impresses with gently curved Premium Porcelain and an impressive relief design with a stately touch, which can also be used to stylishly enhance a modern ambience.

La collection La Scala séduit par sa Premium Porcelain aux courbes douces et par son design expressif en relief. Elle offre une touche d'élégance qui peut également être utilisée avec style dans un cadre moderne.

Die Kollektion La Scala besticht mit sanft geschwungenem Premium Porcelain und einem ausdrucksstarken Relief-Design mit herrschaftlicher Note, das auch in modernem Ambiente stilvoll eingesetzt werden kann.

La colección La Scala deleita con su Premium Porcelain de suaves curvas y un expresivo diseño en relieve provisto de un toque señorial que también puede integrarse con estilo en un entorno moderno.

La collezione La Scala colpisce per la Premium Porcelain delicatamente curvata e un espressivo design a rilievo con un tocco signorile, che può essere utilizzato con stile anche in un ambiente moderno.





OCR 16-3318-0220
Coffeepot N.7 with cover
0,31 | 10½ oz.



OCR 16-3318-0530
Teapot N.5 with cover
0,41 | 13½ oz.



OCR 16-3318-0780
Creamer N.4
0,251 | 8½ oz.



OCR 16-3318-2510
Soup cup
145 x 130 mm · 0,31 | 5½ x 5½" · 10½ oz.



OCR 16-3318-2513
Soup cup stackable
0,41 | 13½ oz.



OCR 16-3318-1250
Saucer
190 mm | 7½"
Ref. 1240, 2510, 2513



OCR 16-3318-0800
Creamer N.6
0,11 | 3½ oz.



OCR 16-3318-0930
Sugar bowl with cover
0,221 | 7½ oz.



OCR 16-3318-1240
Cup N.1
0,31 | 10½ oz.



OCR 16-3318-1280
Saucer
160 mm | 6½"
Ref. 1240, 1270, 1271, 1361, 2510, 4879



OCR 16-3318-1460
Saucer
120 mm | 4½"
Ref. 1450, 1451



OCR 16-3318-2600
Flat plate
290 mm | 11½"



OCR 16-3318-1270
Cup N.2
0,221 | 7½ oz.



OCR 16-3318-1450
Cup N.8
0,091 | 3 oz.



OCR 16-3318-1271
Cup N.2 stackable
0,221 | 7½ oz.



OCR 16-3318-2620
Flat plate
270 mm | 10½"



OCR 16-3318-2630
Flat plate
240 mm | 9"



OCR 16-3318-2640
Flat plate
210 mm | 8½"



OCR 16-3318-1361
Cup N.4 stackable
0,181 | 6 oz.



OCR 16-3318-1451
Cup N.8 stackable
0,091 | 3 oz.



OCR 16-3318-4879
Mug with handle stackable
0,271 | 9½ oz.



OCR 16-3318-2660
Flat plate
160 mm | 6½"



OCR 16-3318-2710
Oval flat plate
360 x 260 mm | 14½ x 10¼"



OCR 16-3318-2720
Oval flat plate
300 x 230 mm | 11½ x 9"





LA SCALA PATINA

Collection

La Scala Patina impresses with its “authentic design”. Striking decorative elements, framed by irregular, hand-painted decorative lines create a hip vintage look – perfect for all trendy locations with a retro style.

La Scala Patina affiche son « design authentique » impressionnant. Ses éléments décoratifs frappants encadrés par des lignes décoratives irrégulières peintes à la main créent un look vintage branché. Parfait pour tous les lieux de style rétro tendance.

La Scala Patina präsentiert sich eindrucksvoll im „Authentic Design“. Markante Schmuckelemente, eingefasst von unregelmäßigen, handgemalten Dekorlinien schaffen einen angesagten Vintage-Look – perfekt für alle Trend-Locations im Retro Style.

La Scala Patina se presenta de forma impresionante en “Authentic Design”. Los llamativos elementos ornamentales enmarcados por líneas decorativas irregulares y pintadas a mano crean un aspecto *vintage* a la moda, perfecto para cualquier lugar de estilo retro en boga.

La Scala Patina si presentata con il suo “Authentic Design” in modo molto espressivo. Elementi decorativi di grande impatto, incorniciati da linee decorative irregolari e dipinte a mano, creano un look vintage di tendenza, perfetto per tutti i luoghi alla moda in stile retro.







MARCHESI

— Collection —

As an homage to the peak of cucina Italiana, the Marchesi dinnerware series is a culinary stage for impressive delicacies. The consistent outer diameter with varying rim widths creates different-sized inner surfaces - ideal for particularly enjoyable arrangements.

Hommage à l'apogée de la Cucina Italiana, la série de vaisselle Marchesi offre une toile de fond culinaire pour des mets impressionnants. Grâce à son diamètre extérieur constant avec une aile de différentes largeurs, des surfaces intérieures de différentes tailles sont créées, ce qui est idéal pour des compositions particulièrement agréables.

Als Hommage an die Spitze der Cucina Italiana, präsentiert sich die Geschirrsreihe Marchesi als kulinarische Bühne für eindrucksvolle Köstlichkeiten. Dank des gleichbleibenden Außendurchmessers mit unterschiedlich breiter Fahne entstehen verschieden große Innenflächen - ideal für besonders genussvolle Arrangements.

La serie de vajillas Marchesi, un homenaje a la cúspide de la *Cucina Italiana*, se presenta como un escenario culinario para impresionantes manjares. Gracias al diámetro exterior uniforme con un borde de diferentes anchos, se crean superficies interiores de diferentes tamaños, lo que resulta ideal para arreglos especialmente agradables.

In omaggio all'eccellenza della Cucina Italiana, la serie di stoviglie Marchesi si propone come palcoscenico culinario per eccezionali prelibatezze. Grazie al diametro esterno costante con la bandiera di diverse larghezze, si creano superfici interne di diverse dimensioni, ideali per impiattamenti particolarmente gradevoli.



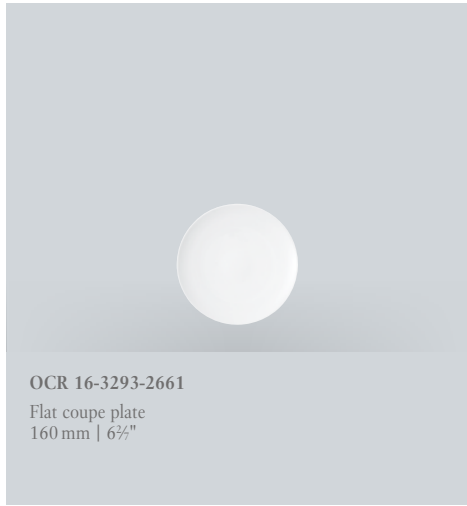
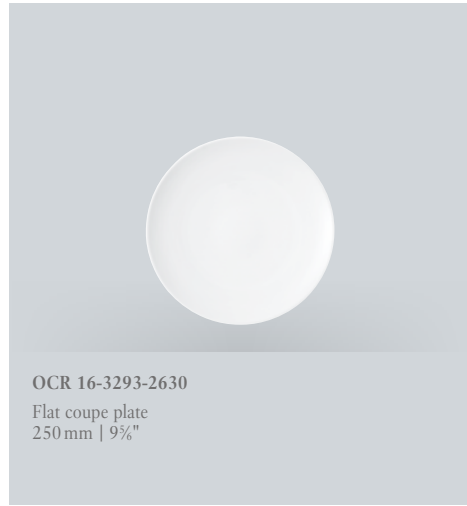
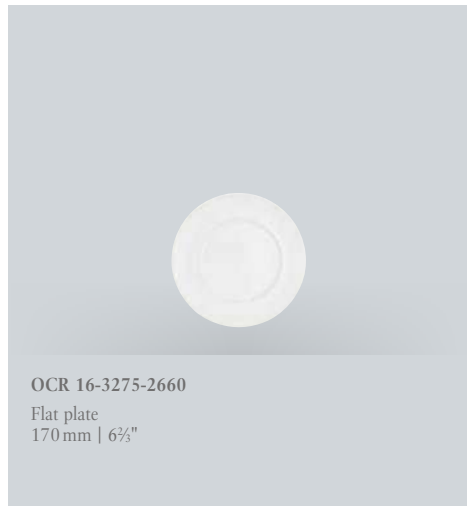



NEUFCHÂTEL CARE

Collection

Neufchâtel Care is tailored to the needs of older and physically impaired people. Developed in cooperation with experts, the collection impresses aesthetically, functionally and ergonomically, and was optimised to ensure intuitive handling: all pieces are easy to hold; the cups feature tipping prevention as well as steep walls and wipe-clean edges.

Neufchâtel Care répond aux besoins des personnes âgées et handicapées. Développée en collaboration avec des experts, cette collection séduit sur le plan esthétique, fonctionnel et ergonomique et permet une utilisation intuitive alliant préhension sûre, protection anti-basculement de la tasse ainsi que parois abruptes et bords racleurs.

Neufchâtel Care ist auf die Bedürfnisse älterer und körperlich eingeschränkter Menschen zugeschnitten. In Kooperation mit Experten entwickelt, überzeugt die Kollektion ästhetisch, funktional sowie ergonomisch und wurde für eine intuitive Handhabung optimiert: Sicheres Greifen aller Teile, Kippschutz der Tasse sowie steile Wände und Abstreifkanten.

Neufchâtel Care se adapta las personas mayores y con discapacidades físicas. Desarrollada junto con expertos, la colección destaca por su estética, funcionalidad y ergonomía, y se ha optimizado para un manejo intuitivo: sujeción segura de todas las piezas, protección antivuelco de la taza, paredes con mucha caída y bordes protuberantes.

Neufchâtel Care è creata per rispondere alle esigenze degli anziani e dei portatori di handicap. Sviluppata insieme ad esperti, la collezione colpisce per estetica, funzionalità ed ergonomia ed è stata ottimizzata per una gestione intuitiva: presa sicura di tutte le parti, protezione anti-ribaltamento della tazza, pareti ripide e bordi smussati.





THE ADVANTAGES AT A GLANCE:

- The top brand for culture, living and dining
- The experience of a more liveable home environment
- Esteem
- Trusted and familiar
- Aids in biographical memory work
- Intuitive use
- Beautiful design
- Making mealtimes a joy
- Mix-and-match
- Quality 'Made in Germany'
- Edge chip warranty
- Tested and certified





NEWMOON

— Collection —

Entice your guests to reach for the stars. Inspired by the fascinating reaches of outer space, NewMoon reinterprets the remarkable crescent shape of the moon as an instant classic for the restaurant and hotel industry. The perfect setting for impressively staged culinary creations.

Mettez les étoiles à portée de main de vos clients. Inspirée de l'immensité de l'univers, NewMoon réinterprète la forme de croissant exceptionnel de la Lune pour en faire un classique de la restauration et de l'hôtellerie. C'est le cadre idéal pour mettre en scène des créations culinaires de manière spectaculaire.

Verleiten Sie Ihre Gäste zum Greifen nach den Sternen. Inspiriert von den faszinierenden Weiten des Weltraums, interpretiert NewMoon die außergewöhnliche Sichelform des Mondes zu einem eindrucksvollen Klassiker der Gastronomie und Hotellerie. Das perfekte Setting um kulinarische Kreationen eindrucksvoll zu inszenieren.

Conduzca a sus invitados hacia las estrellas. Inspirada en la fascinante inmensidad del espacio exterior, NewMoon interpreta la extraordinaria forma de media luna convirtiéndola en un impresionante clásico de la gastronomía y la hostelería. El escenario perfecto para las creaciones culinarias.

Invogliate i vostri ospiti a compiere un viaggio verso le stelle. Ispirata dall'affascinante vastità dello spazio, la serie NewMoon interpreta l'insolita forma a falce della luna in un eccezionale classico della gastronomia e del settore alberghiero. La cornice perfetta per mettere in scena creazioni culinarie di grande effetto.



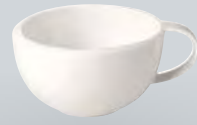

OCR 10-4264-1300
Cup
130 x 105 x 60 mm · 0,291 | 5¼ x 4½ x 2½" · 9½ oz.



OCR 10-4264-1420
Cup
90 x 70 x 50 mm · 0,11 | 3½ x 2¾ x 2" · 3½ oz.



OCR 10-4264-9651
Mug with handle
125 x 90 x 95 mm · 0,391 | 5 x 3½ x 3¾" · 13½ oz.



OCR 10-4264-2660
Flat plate
160 x 160 x 20 mm | 6½ x 6½ x ¾"



OCR 10-4264-2680
Flat plate
320 x 320 x 25 mm | 12½ x 12½ x 1"



OCR 10-4264-2700
Deep bowl
290 x 290 x 50 mm · 1,71 | 11½ x 11½ x 2" · 57½ oz.

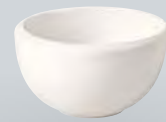

OCR 10-4264-1306
Unhandled cup
105 x 105 x 60 mm · 0,281 | 4¼ x 4¼ x 2½" · 9½ oz.

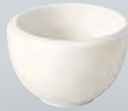

OCR 10-4264-1455
Unhandled cup
70 x 70 x 45 mm · 0,11 | 2¾ x 2¾ x 1⅞" · 3½ oz.



OCR 10-4264-9660
Mug without handle
90 x 90 x 95 mm · 0,41 | 3½ x 3½ x 3¾" · 13½ oz.



OCR 10-4264-2701
Flat bowl
250 x 250 x 40 mm · 0,91 | 9¾ x 9¾ x 1½" · 30½ oz.



OCR 10-4264-1900
Bowl
165 x 165 x 65 mm · 0,751 | 6½ x 6½ x 2½" · 25½ oz.

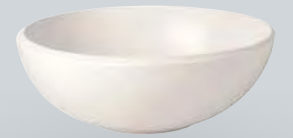

OCR 10-4264-3160
Salad bowl
285 x 285 x 105 mm · 4,01 | 11½ x 11½ x 4½" · 135¼ oz.



OCR 10-4264-1310
Saucer
170 x 170 x 20 mm | 6⅝ x 6⅝ x ⅝"
Ref. 1300, 1306



OCR 10-4264-1430
Saucer
130 x 130 x 20 mm | 5⅝ x 5⅝ x ⅝"
Ref. 1420, 1455



OCR 10-4264-2990
Presentation tray
370 x 370 x 30 mm | 14¾ x 14¾ x 1½"



OCR 10-4264-3170
Salad bowl
235 x 235 x 85 mm · 2,151 | 9¼ x 9¼ x 3⅝" · 72½ oz.



OCR 10-4264-3180
Salad bowl
180 x 50 x 185 mm · 1,051 | 7 x 2 x 7½" · 35½ oz.



OCR 10-4264-3900
Individual bowl
130 x 130 x 45 mm · 0,281 | 5⅝ x 5⅝ x 1⅞" · 9½ oz.



OCR 10-4264-2601
Flat plate
290 x 290 x 25 mm | 11½ x 11½ x 1"



OCR 10-4264-2620
Flat plate
270 x 270 x 25 mm | 10⅝ x 10⅝ x 1"



OCR 10-4264-2640
Flat plate
240 x 240 x 20 mm | 9⅝ x 9⅝ x ¾"



OCR 10-4264-3932
Dip bowl
85 x 85 x 35 mm · 0,111 | 3⅓ x 3⅓ x 1⅓" · 3½ oz.



NEWWAVE

— Collection —

The exceptional dinnerware series NewWave impresses with a particularly powerful look. A variety of geometric shapes is perfectly staged with a progressive wave design. The puristic white Premium Porcelain leaves plenty of design freedom for highly personalised accents.

L'extraordinaire série de vaisselle NewWave séduit par son look particulièrement expressif. Une grande variété de formes géométriques sont parfaitement mises en scène avec un design d'ondulations progressives. Le blanc épuré de sa Premium Porcelain laisse une grande liberté aux touches personnelles.

Die außergewöhnliche Geschirrsreihe NewWave besticht durch einen besonders kraftvollen Look. Eine Vielzahl geometrischer Formen wird mit einem progressiven Wellendesign perfekt in Szene gesetzt. Das puristisch weiße Premium Porcelain lässt dabei viel Gestaltungsspielraum für ganz persönliche Akzente.

La extraordinaria serie de vajilla NewWave impresiona con un aspecto particularmente poderoso. Una variedad de formas geométricas se escenifica perfectamente con un diseño de ondas progresivas. El blanco purista de la Premium Porcelain deja mucho espacio para los toques personales.

La straordinaria serie di stoviglie NewWave convince per il suo aspetto particolarmente potente. Una moltitudine di forme geometriche è perfettamente messa in scena con un progressivo design ondulato. La Premium Porcelain bianca candida lascia molta libertà di creazione per esprimere il proprio tocco personale.





OCR 10-2484-1210
Café au lait cup
0,41 | 13½ oz.



OCR 10-2484-9651
Mug with handle
0,31 | 10½ oz.



OCR 10-2484-1330
Cappuccino cup
0,251 | 8½ oz.



OCR 10-2525-2528
Saucer soup cup
180 x 150 mm | 7 x 6"
Ref. 2519

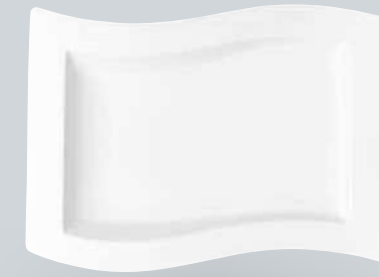

OCR 10-2525-2281
Rectangular platter
490 x 300 mm | 19½ x 11½"



OCR 10-2525-2809
Square platter
340 x 340 mm | 13½ x 13½"



OCR 10-2484-9631
Mug with handle
0,251 | 8½ oz.



OCR 10-2525-1300
Cup
0,21 | 6¼ oz.



OCR 10-2484-1425
Espresso cup
0,081 | 2½ oz.



OCR 10-2525-2699
Flat rectangular plate
330 x 240 mm | 13 x 9½"



OCR 10-2525-2855
Grill plate
270 x 270 mm | 10½ x 10½"



OCR 10-2525-2619
Flat square plate
270 x 270 mm | 10½ x 10½"



OCR 10-2484-2830
Partyplate
220 x 170 mm | 8½ x 6½"
Ref. 1210, 1330, 9651



OCR 10-2484-2832
Partyplate
200 x 140 mm | 7½ x 5½"
Ref. 1300, 1330, 9631, 9651



OCR 10-2484-2831
Partyplate
170 x 130 mm | 6½ x 5½"
Ref. 1425



OCR 10-2525-2647
Flat square plate
240 x 240 mm | 9½ x 9½"



OCR 10-2525-2698
Pasta plate
280 x 280 mm · 0,71 | 11 x 11" · 23½ oz.



OCR 10-2525-2709
Deep square plate
240 x 240 mm · 0,351 | 9½ x 9½" · 11½ oz.



OCR 10-2525-1311
Saucer
180 x 150 mm | 7 x 6"
Ref. 1300, 9631



OCR 10-2525-1431
Saucer
140 x 110 mm | 5½ x 4½"
Ref. 1425



OCR 10-2525-2519
Soup cup
0,451 | 15½ oz.



OCR 10-2525-2649
Dessert plate
240 x 220 mm | 9½ x 8½"
Ref. 1900



OCR 10-2525-2659
Flat triangular plate
220 x 220 mm | 8½ x 8½"



OCR 10-2525-2665
Bread plate
150 x 130 mm | 6 x 5½"



OCR 10-2525-3570
Pickle dish
210 x 150 mm | 8¼ x 6"



OCR 10-2525-3320
Salad bowl
330 x 330 mm · 3,65l | 13 x 13" · 123½ oz.



OCR 10-2525-3330
Salad bowl
250 x 250 mm · 1,7l | 9" x 9" · 57½ oz.



OCR 10-2525-1901
Individual bowl
0,35l | 11% oz.



OCR 10-2525-1909
Bowl
0,6l | 20% oz.



OCR 10-2525-3933
Dip bowl with handle
0,06l | 2 oz.



OCR 10-2525-2590
Flat gourmet plate
300 mm | 11½"



OCR 10-2525-2640
Flat plate
250 mm | 9"

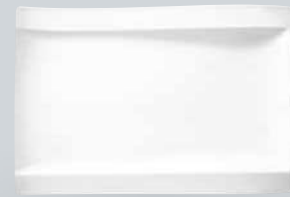

OCR 10-2525-2697
Flat gourmet rectangular plate
370 x 250 mm | 14½ x 9"



OCR 10-2525-3890
Move Individual bowl
280 x 150 mm · 0,6l | 11 x 6" · 20% oz.



OCR 10-2525-3891
Move Individual bowl
140 x 150 mm · 0,28l | 5½ x 6" · 9½ oz.



OCR 10-2525-3934
Individual bowl
120 x 120 mm · 0,32l | 4½ x 4½" · 10% oz.



OCR 10-2525-2646
Flat rectangular plate
260 x 200 mm | 10¼ x 7¾"



OCR 10-2525-2596
Flat rectangular antipasti plate
420 x 150 mm | 16½ x 6"



OCR 10-2525-2660
Flat rectangular plate
180 x 150 mm | 7 x 6"



OCR 10-2525-3932
Dip bowl
85 x 85 mm · 0,12l | 3½ x 3½" · 4 oz.



OCR 10-2525-1955
Egg cup
130 x 90 mm | 5½ x 3½"



OCR 10-2525-3470
Salt shaker
70 x 40 mm | 2¾ x 1½"



OCR 10-2525-3160
Salad bowl
4,5l | 152% oz.



OCR 10-2525-3170
Salad bowl
3,0l | 101% oz.



OCR 10-2525-1900
Bowl
0,6l | 20% oz.



OCR 10-2525-3480
Pepper shaker
70 x 40 mm | 2¾ x 1½"



PI CARRÉ

— Collection —

First-class serving! The compact, angular design of Pi Carré offers endless opportunities for your creative cuisine. The intelligent shape system makes it possible to combine different items to create ever-new, exciting table compositions.

Pour un service de première classe! Le design compact et angulaire de Pi Carré offre des possibilités infinies pour votre cuisine créative. Grâce à son système de formes intelligent, les différents éléments peuvent être combinés pour créer des compositions de table passionnantes et sans cesse différentes.

Erstklassiges Servieren! Das kompakte, eckige Design von Pi Carré bietet unendlich viele Möglichkeiten für Ihre kreative Küche. Dank des intelligenten Formensystems lassen sich die verschiedenen Artikel zu immer wieder neuen, aufregenden Tischkompositionen kombinieren.

¡Servicio de primera clase! El diseño compacto y angular de Pi Carré ofrece infinitas posibilidades para su cocina creativa. Gracias al sistema inteligente de formas, los distintos elementos pueden combinarse para crear composiciones de mesa siempre nuevas y emocionantes.

Per un servizio di prima classe! Il design compatto e spigoloso di Pi Carré offre infinite possibilità per la vostra cucina creativa. Grazie all'intelligente sistema di forme, i vari elementi possono essere combinati per creare nuove ed emozionanti composizioni a tavola.



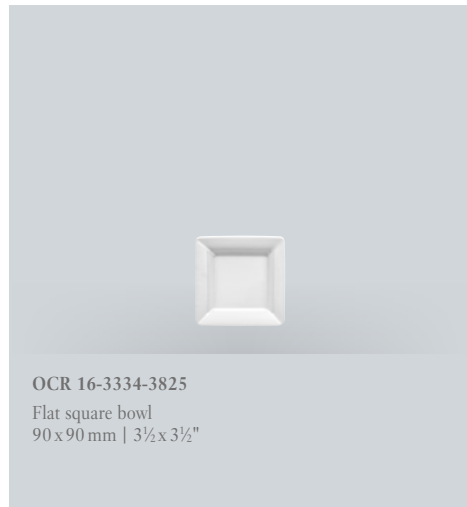



SEDONA

— Collection —

White on white - the interplay of different shades of white paired with harmonious relief lines is particularly refined and sophisticated. The round, organically shaped Premium Porcelain is ideal for presenting fine gourmet food in the world of fine dining and for exquisite enjoyment at festive banquets.

Blanc sur blanc : l'association de deux nuances de blanc à des lignes harmonieuses en relief dégage un raffinement et une exclusivité particulières. La Premium Porcelain ronde et de forme organique, est idéale pour la mise en scène des mets raffinés de la haute gastronomie et pour une dégustation exquise lors de banquets festifs.

White on white - das Zusammenspiel von verschiedenen Weißtönen, gepaart mit harmonischen Relief-Linien wirkt besonders raffiniert und anspruchsvoll. Das runde, organisch geformte Premium Porcelain eignet sich hervorragend zur Inszenierung edler Delikatessen des Fine Dining als auch zum exquisiten Genuss festlichen Banketts.

Blanco sobre blanco: la combinación de dos tonos diferentes de blanco con las armoniosas líneas de relieve resulta especialmente delicada. La Premium Porcelain, redonda y de forma orgánica, es ideal para poner en escena manjares de alta cocina, así como para disfrutar al máximo en banquetes festivos.

White on white - l'interazione di diverse tonalità di bianco abbinata ad armoniche linee in rilievo ha un effetto particolarmente raffinato ed espressivo. La Premium Porcelain dalla forma rotonda e organica è l'ideale per mettere in scena prelibatezze in una cucina raffinata e per godersi squisitamente i banchetti delle feste.





OCR 16-3356-0220
Coffeepot N.7 with cover
0,31 | 10½ oz.



OCR 16-3356-0530
Teapot N.5 with cover
0,41 | 13½ oz.



OCR 16-3356-0800
Creamer N.6
0,151 | 5 oz.

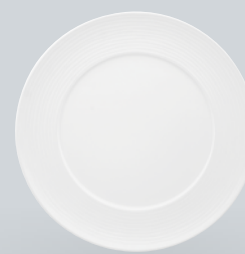

OCR 16-3356-2590
Flat plate
320 mm | 12½"



OCR 16-3356-2600
Flat plate
290 mm | 11½"



OCR 16-3356-2660
Flat plate
160 mm | 6½"



OCR 16-3356-0930
Sugar bowl with cover
0,161 | 5½ oz.



OCR 16-3356-1270
Cup N.2
0,221 | 7½ oz.



OCR 16-3356-1360
Cup N.4
0,181 | 6 oz.



OCR 16-3356-2630
Flat plate
250 mm | 9½"



OCR 16-3356-2665
Flat plate
170 mm | 6½"



OCR 16-3356-2595
Flat coupe plate
320 mm | 12½"



OCR 16-3356-1450
Cup N.8
0,081 | 2½ oz.



OCR 16-3356-1271
Cup N.2 stackable
0,221 | 7½ oz.



OCR 16-3356-1361
Cup N.4 stackable
0,181 | 6 oz.



OCR 16-3356-2621
Flat coupe plate
290 mm | 11½"



OCR 16-3356-2631
Flat coupe plate
250 mm | 9½"



OCR 16-3356-2650
Flat coupe plate
210 mm | 8¼"



OCR 16-3356-1451
Cup N.8 stackable
0,081 | 2½ oz.



OCR 16-3356-1280
Saucer
160 mm | 6½"
Ref. 1270, 1271, 1360, 1361



OCR 16-3356-1460
Saucer
130 mm | 5½"
Ref. 1450, 1451



OCR 16-3356-2661
Flat coupe plate
160 mm | 6½"



OCR 16-3356-2700
Deep plate
290 x 140 mm · 0,321 | 11½ x 5½" · 10½ oz.



OCR 16-3356-2701
Deep coupe plate
290 mm · 0,281 | 11½" · 9½ oz.





SEDONA FUNCTION

Collection

The subtle relief decor of Sedona Function becomes a stylish platform for culinary delicacies, both in modern and classic environments. Thanks to the functional diversity of its shapes, Sedona Function is the ideal dinnerware series for all service areas in ambitious gastronomy.

Le décor au relief discret de Sedona Function offre une toile de fond élégante pour des délices culinaires dans des ambiances modernes et classiques. Grâce à la variété fonctionnelle des formes, Sedona Function est la série de vaisselle idéale pour tous les domaines du service de la gastronomie audacieuse.

Das dezente Relief-Dekor von Sedona Function avanciert sowohl im modernen als auch im klassischen Ambiente zu einer stilvollen Bühne für kulinarische Köstlichkeiten. Dank der funktionalen Formenvielfalt ist Sedona Function die ideale Geschirrsreihe für alle Servicebereiche der ambitionierten Gastronomie.

La discreta decoración en relieve de Sedona Function es un elegante escenario para las delicias culinarias en ambientes modernos y clásicos. Gracias a la variedad funcional de formas, Sedona Function es la vajilla ideal para todas las áreas de servicio en la gastronomía ambiciosa.

Il sobrio decoro in rilievo di SedonaFunction diventa un palcoscenico elegante per prelibatezze culinarie in un ambiente sia moderno che classico. Grazie alla varietà funzionale delle forme, SedonaFunction è la serie di stoviglie ideale per tutti gli ambiti di servizio nella gastronomia più ambiziosa.



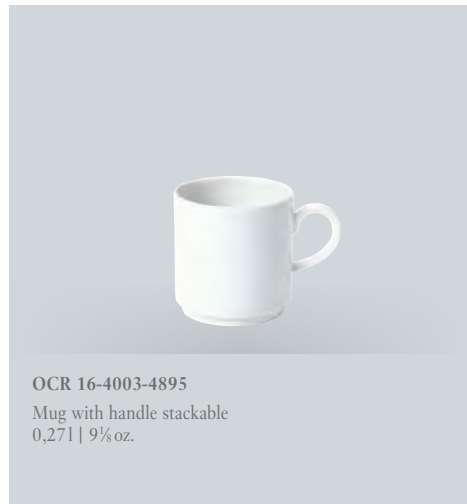



THE ROCK

— Collection —

A true reflection of nature: the minimalistic, expressive design of The Rock is inspired by natural slate shapes, which are transferred to the finest Premium Porcelain using highly demanding processes that recreate their natural look and feel.

Un véritable reflet de la nature : le design minimaliste et expressif de The Rock est basé sur les formes de l'ardoise naturelle, dont l'aspect et le toucher sont imités grâce à un procédé complexe réalisé sur une Premium Porcelain des plus raffinées.

Ein wahres Spiegelbild der Natur: Das minimalistische, ausdrucksstarke Design von The Rock ist natürlichen Schiefergesteinsformen nachempfunden und wird optisch und haptisch in höchst anspruchsvollen Verfahren auf feinstes Premium Porcelain übertragen.

Un verdadero reflejo de la naturaleza: el diseño minimalista y expresivo de The Rock emula las formas naturales de la roca de pizarra y, mediante un procedimiento muy laborioso, su aspecto y su textura se transfieren a la Premium Porcelain más delicada.

Un vero e proprio riflesso della natura: Il design minimale e straordinario di The Rock è ispirato alle forme naturali dell'ardesia che, con processi altamente sofisticati, vengono trasferite a livello estetico e tattile alla Premium Porcelain di alta qualità.



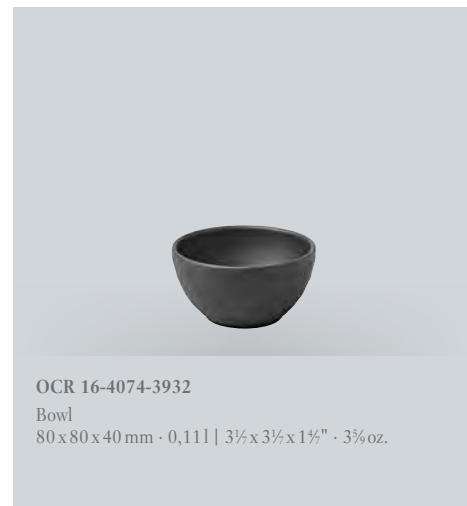
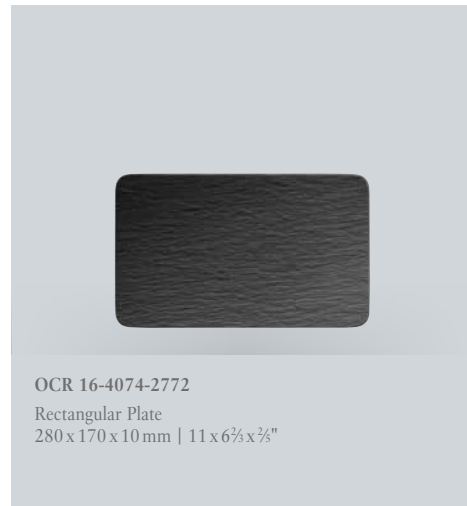
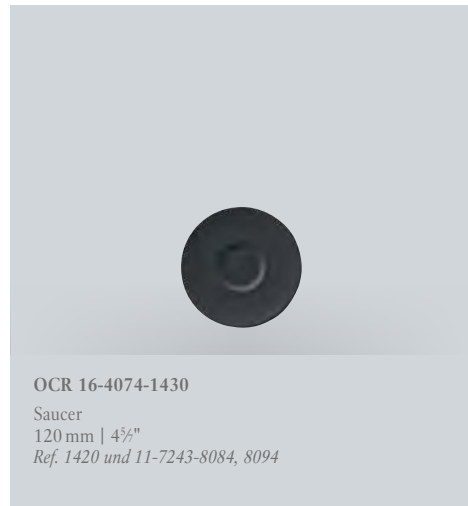
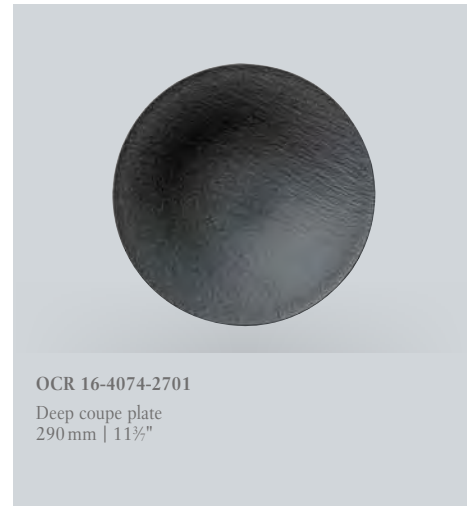

Cover Seal by Villeroy & Boch is the new metallic-effect surface finish – durable, dishwasher-safe, microwave-safe and salamander-safe.



OCR 16-4077-9651
Mug with handle
120 x 90 x 105 mm · 0,351 | 4½ x 3½ x 4½" · 11½ oz.



OCR 16-4077-1300
Cup
105 x 80 x 75 mm · 0,221 | 4½ x 3½ x 3" · 7½ oz.



OCR 16-4077-1420
Cup
85 x 65 x 60 mm · 0,11 | 3½ x 2½ x 2½" · 3½ oz.



OCR 16-4077-1220
Saucer
173 mm | 6¾"
Ref. 1300 und 11-7243-8086, 8096, 8088, 8098, 8089, 8099



OCR 16-4077-1310
Saucer
155 x 155 x 20 mm | 6¼ x 6¼ x ¾"
Ref. 1300 und 11-7243-8085, 8095



OCR 16-4077-1430
Saucer
120 mm | 4¾"
Ref. 1420 und 11-7243-8084, 8094



OCR 16-4077-2595
Flat coupe plate
317 mm | 12½"



OCR 16-4077-2621
Flat coupe plate
290 mm | 11¾"



OCR 16-4077-2630
Flat coupe plate
250 mm | 9¾"



OCR 16-4077-2650
Flat coupe plate
210 mm | 8¼"



OCR 16-4077-2661
Flat coupe plate
160 mm | 6½"



OCR 16-4077-2620
Flat plate
270 mm | 10¾"



OCR 16-4077-2640
Flat plate
220 mm | 8 3/4"



OCR 16-4077-2700
Deep plate
280 x 140 mm · 0,261 | 11 x 5 1/2" · 8 3/4 oz.



OCR 16-4077-2701
Deep coupe plate
290 mm | 11 1/2"



OCR 16-4077-2281
Rectangular Plate
350 x 180 x 10 mm | 13 3/4 x 7 x 3/8"



OCR 16-4077-2772
Rectangular Plate
280 x 170 x 10 mm | 11 x 6 3/4 x 3/8"



OCR 16-4077-2680
Flat square plate
325 x 325 x 15 mm | 12 3/4 x 12 3/4 x 3/8"



OCR 16-4077-2610
Flat square plate
280 x 280 x 20 mm | 11 x 11 x 3/8"



OCR 16-4077-1900
Bowl
140 mm · 0,651 | 5 1/2" · 22 oz.



OCR 16-4077-3932
Bowl
80 x 80 x 40 mm · 0,111 | 3 1/4 x 3 1/4 x 1 1/2" · 3 3/4 oz.



OCR 16-4077-2536
Flat bowl
235 mm · 1,11 | 9 1/4" · 37 1/2 oz.



OCR 10-4240-2535
Soup bowl
130 x 130 x 65 mm · 0,321 | 5 1/4 x 5 1/4 x 2 1/2" · 10 3/4 oz.



OCR 10-4240-1905
Rice bowl
110 x 110 x 60 mm · 0,221 | 4 1/4 x 4 1/4 x 2 1/4" · 7 1/2 oz.



OCR 11-7243-8099
Glass Universal set 2 pcs.
122 mm · 0,391 | 4 7/8" · 13 1/2 oz.



OCR 11-7243-8098
Glass XL set 2 pcs.
140 mm · 0,451 | 5 1/2" · 15 3/4 oz.



OCR 11-7243-8096
Glass L set 2 pcs., 95 mm · 0,421 | 3 3/4" · 14 1/2 oz.
-8095 M, 80 mm · 0,221 | 3 1/2" · 7 3/4 oz.
-8094 S, 68 mm · 0,111 | 2 3/4" · 3 3/4 oz.



OCR 11-7243-8089
Universal Cup set 2 pcs.
122 mm · 0,391 | 4 7/8" · 13 1/2 oz.



OCR 11-7243-8088
Cup XL set 2 pcs.
140 mm · 0,451 | 5 1/2" · 15 3/4 oz.



OCR 11-7243-8086
Cup L set 2 pcs., 95 mm · 0,421 | 3 3/4" · 14 1/2 oz.
-8085 M, 80 mm · 0,221 | 3 1/2" · 7 3/4 oz.
-8084 S, 68 mm · 0,111 | 2 3/4" · 3 3/4 oz.



OCR 10-4283-1220
Saucer white coffee cup
170 x 170 x 20 mm | 6 3/4 x 6 3/4 x 3/8"
Ref. 16-4074-1300 und 11-7243-8096, 8086, 8088, 8098, 8089, 8099



OCR 10-4283-1310
Saucer coffee cup
155 x 155 x 20 mm | 6 1/8 x 6 1/8 x 3/8"
Ref. 16-4074-1300 und 11-7243-8085, 8095



OCR 10-4283-1430
Saucer espresso cup
120 x 120 x 20 mm | 4 3/4 x 4 3/4 x 3/8"
Ref. 16-4074-1420 und 11-7243-8084, 8094



OCR 10-4283-1900
Bowl
140 x 140 x 70 mm · 0,651 | 5 1/2 x 5 1/2 x 2 3/4" · 22 oz.



OCR 10-4283-2536
Bowl flat
235 x 235 mm · 1,11 | 9 1/4 x 9 1/4" · 37 1/2 oz.

10 YEARS



EDGE CHIP WARRANTY



UNIVERSAL

— Collection —

The sleek classic design of Universal is reduced to the essentials, blending seamlessly into the most varied of arrangements. Universally applicable and versatile in combination, the collection is the ideal addition to all Villeroy & Boch Premium Porcelain series - or equally impresses as a stylish, stand-alone design.

Le design simple et classique d'Universal réduit à l'essentiel s'intègre donc parfaitement à une grande variété de compositions. Offrant une utilisation universelle et permettant diverses combinaisons, cette collection est idéale pour compléter toutes les séries en Premium Porcelain de Villeroy & Boch ou pour impressionner seule par son élégance.

Das schlichte, klassische Design von Universal ist auf das Wesentliche reduziert und fügt sich somit hervorragend in die verschiedensten Arrangements ein. Universell einsetzbar und vielfältig kombinierbar, eignet sich die Kollektion hervorragend als Ergänzung aller Villeroy & Boch Premium Porcelain Serien oder überzeugt als stilvolles Stand Alone.

El diseño sencillo y clásico de Universal se reduce a lo esencial, por lo que se adapta perfectamente a una gran variedad de arreglos. Universal y combinable de múltiples maneras, la colección es ideal como complemento de todas las series de Premium Porcelain de Villeroy & Boch o como un elemento de diseño independiente.

Il design semplice e classico di Universal è ridotto all'essenziale e si adatta perfettamente ai più svariati impiattamenti. Utilizzabile in modo universale e combinabile con versatilità, la collezione è ideale come integrazione per tutte le serie Villeroy & Boch Premium Porcelain ma è perfetta anche da sola.



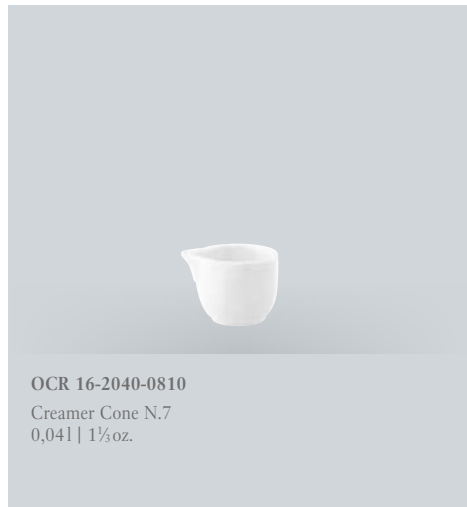



OCR 16-2040-4831
Deep gourmet plate
200 mm · 0,351 | 7 7/8" · 11 1/2 oz.



OCR 16-2040-2771
Bento partyplate
260 x 190 mm | 10 1/4 x 7 1/2"



OCR 16-2040-3792
Oval bowl stackable
120 x 100 mm · 0,331 | 4 3/4 x 4" · 11 1/2 oz.



OCR 16-2040-3791
Oval bowl stackable
105 x 85 mm · 0,21 | 4 1/8 x 3 3/8" · 6 3/8 oz.



OCR 16-2040-3790
Oval bowl stackable
90 x 75 mm · 0,131 | 3 1/2 x 3" · 4 3/8 oz.



OCR 16-2040-3450
Sauceboat
210 x 100 mm · 0,41 | 8 1/4 x 4" · 13 1/2 oz.



OCR 16-2040-3430
Sauceboat
110 x 75 mm · 0,11 | 4 1/8 x 3" · 3 3/8 oz.



OCR 16-2040-3960
Coaster / butter plate
120 mm | 4 3/8"



OCR 16-2040-1950
Egg cup/Dip bowl
45 mm · 0,071 | 1 7/8" · 2 3/8 oz.



OCR 16-2040-1951
Egg cup with integral saucer
148 x 114 mm | 5 7/8 x 4 1/2"



OCR 16-2040-3850
Dip bowl stackable
65 mm · 0,11 | 2 5/8" · 3 3/8 oz.



OCR 16-2040-3975
Flat individual bowl
60 mm · 0,051 | 2 1/8" · 1 3/8 oz.



OCR 16-2040-3470
Salt shaker
55 mm | 2 1/8"



OCR 16-2040-3480
Pepper shaker
55 mm | 2 1/8"



OCR 16-2040-5031
Vase
140 mm · 0,131 | 5 1/2" · 4 3/8 oz.



OCR 16-2040-4060
Round ashtray
85 mm | 3 1/8"



URBAN NATURE

Collection

Urban Nature combines natural lines with an urban lifestyle. The clean design and the pure white of the Premium Porcelain can be combined in versatile ways and offer the ideal opportunity to effectively serve and present delicacies.

Urban Nature associe des lignes naturelles et un art de vivre urbain. Son esthétique net et le blanc épuré de la Premium Porcelain peuvent être combinés de nombreuses façons et offrent l'occasion idéale de servir et de réaliser des présentations de mets délicats du plus bel effet.

Urban Nature verbindet natürliche Linienführung mit urbanem Lifestyle. Die klare Formensprache und das puristische Weiß des Premium Porcelain lassen sich vielseitig kombinieren und bieten die ideale Möglichkeit, delikate Köstlichkeiten wirkungsvoll zu servieren und zu präsentieren.

Urban Nature combina las líneas naturales con el estilo de vida urbano. El lenguaje de diseño claro y el blanco purista de la Premium Porcelain pueden combinarse de muchas maneras y ofrecen la oportunidad ideal para servir y presentar delicados manjares dejando huella.

Urban Nature combina linee naturali con uno stile di vita urbano. Il chiaro linguaggio formale e il bianco candido della Premium Porcelain possono essere combinati con versatilità e offrono l'opportunità ideale per servire e presentare in modo efficace delicate prelibatezze.





OCR 10-3452-2906
Fruit traverse
500 x 260 mm | 19½ x 10¼"



OCR 10-3452-2916
Traverse
420 x 240 mm | 16½ x 9½"



OCR 10-3452-3876
Pasta traverse
500 x 270 mm | 19 2/3 x 10 5/8"



OCR 10-3452-3877
Oval platter
420 x 255 mm | 16½ x 10"



OCR 10-3452-3878
Oval platter
350 x 240 mm | 13¾ x 9½"



OCR 10-3452-3170
Traverse
250 x 200 mm · 2,11 | 9¾ x 7¾" · 71 oz.



OCR 10-3452-6050
Fruit traverse
575 x 265 mm · 2,21 | 22½ x 10½" · 74½ oz.



OCR 10-3452-6051
Traverse
370 x 140 mm · 0,21 | 14¾ x 5½" · 6¼ oz.

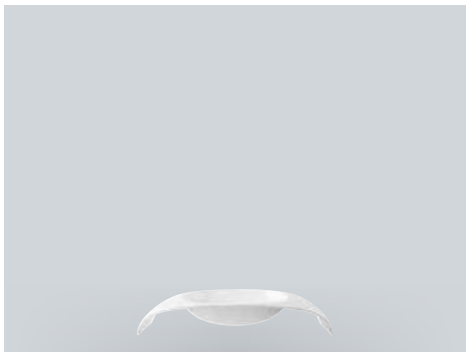

OCR 10-3452-6052
Traverse
260 x 115 mm · 0,151 | 10¼ x 4½" · 5 oz.

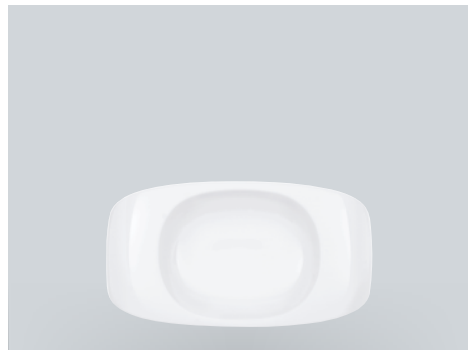

OCR 10-3452-6065
Pasta traverse
350 x 180 mm · 0,581 | 13¾ x 7" · 19¾ oz.



like.

TREND RANGE

like. is the new and young on-trend brand from Villeroy & Boch that combines multifunctional and sustainable products with creative designs and a handmade character. The result is trendy pottery styles and hip to-go products in modern shapes and colours. What makes it so special? All products are made of our high-quality Premium Porcelain.

like. est la nouvelle marque de Villeroy & Boch, qui associe des produits multifonctions et durables avec des designs créatifs et un caractère artisanal. Elle offre des looks poterie tendance et des produits To Go aux formes et couleurs modernes. Sa particularité : tous ses produits sont en Premium Porcelain de haute qualité.

like. ist die neue und junge Trendmarke von Villeroy & Boch, die multifunktionalen und nachhaltigen Produkte mit kreativen Designs und handgemachtem Charakter kombiniert. Daraus entstehen trendige Pottery Looks und angesagte To Go Produkte in modernen Formen und Farben. Das Besondere: Alle Produkte sind aus hochwertigem Premium Porcelain.

like. es la nueva y juvenil marca de tendencia de Villeroy & Boch, que combina productos multifuncionales y sostenibles con diseños creativos y artesanía. El resultado es un aspecto cerámico de moda y atractivos productos To Go con formas y colores modernos. Su característica especial: todos los productos son de Premium Porcelain de alta calidad.

like. è il nuovo marchio giovane e di tendenza di Villeroy & Boch che unisce prodotti funzionali e sostenibili a design creativi e a un carattere artigianale. Questo crea look Pottery alla moda e prodotti di tendenza per l'asporto dalle forme e dai colori moderni. La particolarità: Tutti i prodotti sono realizzati in pregiata Premium Porcelain.





RANGE OVERVIEW

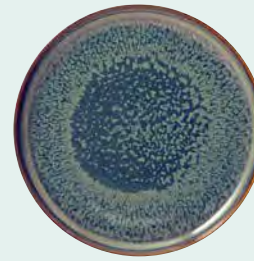

CRAFTED BREEZE
p. 162



CRAFTED DENIM
p. 165



CRAFTED BLUEBERRY
p. 166



TO GO & TO STAY
p. 168



COFFEE TO GO
p. 172



TO GO
p. 176



CRAFTED

— Collection —

The Crafted collection focuses on an authentic pottery look made of the finest Premium Porcelain - with the perfect interplay of trendy design and maximum functionality. Thanks to the special reactive glaze, every piece is one of a kind with slightly different tones and textures.

La collection Crafted mise sur un look poterie authentique en Premium Porcelain, c'est la combinaison parfaite d'un design tendance et de la plus haute qualité. Grâce à l'émail réactif spécial, chaque pièce est unique et présente des tons et des textures légèrement différents.

Die Kollektion Crafted setzt auf einen authentischen Pottery Look aus feinstem Premium Porcelain - die perfekte Kombination aus trendigem Design und höchster Funktionalität. Dank der speziellen Reaktivglasur ist jedes Stück ein Unikat mit leicht unterschiedlichen Tönen und Texturen.

La colección Crafted se caracteriza por un auténtico estilo cerámico con la mejor Premium Porcelain: la combinación perfecta de diseño moderno y máxima funcionalidad. Su especial esmalte reactivo convierte cada pieza en algo único, con tonos y texturas que difieren ligeramente.

Crafted La collezione Crafted si basa su un autentico look Pottery realizzato in finissima Premium Porcelain: la perfetta combinazione di design alla moda e massima funzionalità. Grazie allo speciale smalto reattivo, ogni pezzo è unico, caratterizzato da tonalità e texture con leggere differenze.





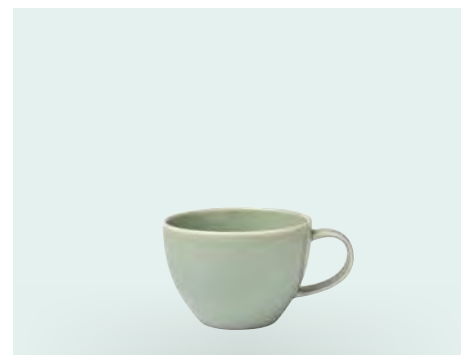

OCR 19-5169-1300
Cup
120 x 90 x 60 mm · 0,251 | 4½ x 3½ x 2½" · 8½ oz.



OCR 19-5169-9651
Mug with handle
120 x 90 x 100 mm · 0,351 | 4½ x 3½ x 4" · 11½ oz.

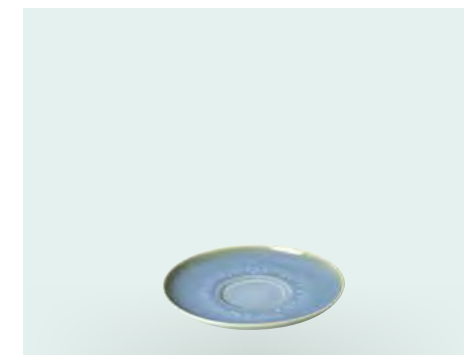

OCR 19-5169-1310
Saucer
150 x 150 x 20 mm | 6 x 6 x ½"
Ref. 1300



OCR 19-5169-1900
Bowl
160 x 160 x 60 mm · 0,751 | 6½ x 6½ x 2½" · 25½ oz.



OCR 19-5169-2610
Flat plate
260 x 260 x 20 mm | 10¼ x 10¼ x ¾"



OCR 19-5169-2640
Flat plate
210 x 210 x 20 mm | 8¼ x 8¼ x ¾"



OCR 19-5169-2700
Deep plate
215 x 215 x 35 mm · 0,811 | 8½ x 8½ x 1⅜" · 27¼ oz.



TO GO & TO STAY

Collection

To Go & To Stay is the on-trend alternative for anyone who wants to offer their guests an environmentally friendly way of enjoying food on the go. Our modern takeaway solution reflects the current zeitgeist: greater sustainability and avoidance of plastic. The high-quality materials guarantee an unadulterated dining experience.

To Go & To Stay est l'alternative tendance pour proposer aux clients des repas à emporter tout en respectant l'environnement. Notre solution à emporter moderne reflète totalement l'esprit de notre époque: une plus grande durabilité et un abandon du plastique. Ses matériaux de haute qualité garantissent une expérience authentique de la gastronomie.

To Go & To Stay ist die trendbewusste Alternative für all diejenigen, die Ihren Gästen umweltbewusst Mahlzeiten für unterwegs anbieten möchten. Damit trifft unsere moderne Take Away Lösung den aktuellen Zeitgeist: Für mehr Nachhaltigkeit und Verzicht auf Plastik. Die hochwertigen Materialien garantieren eine unverfälschte Dining Experience.

To Go & To Stay es una moderna alternativa para quienes desean ofrecer a sus invitados unos platos para llevar que sean respetuosos con el medio ambiente. Nuestra moderna solución para llevar se adapta a las tendencias de hoy: más sostenibilidad y menos plásticos. Los materiales de alta calidad garantizan una auténtica experiencia gastronómica.

To Go & To Stay è l'alternativa di tendenza per tutti coloro che desiderano offrire ai propri ospiti la possibilità di consumare pasti fuori casa in modo ecologico. Questa moderna soluzione "take away" incontra così le tendenze attuali: più sostenibilità e rinuncia alla plastica. I materiali di qualità garantiscono un'esperienza culinaria genuina.





OCR 10-4869-9340
Mug with lid large
0,45l | 15% oz.



OCR 10-4869-9334
Mug with lid small
0,32l | 10% oz.



OCR 10-4869-7995
Drinking Bottle black
83 mm · 1,0l | 3¼" · 33% oz.



OCR 10-4869-9419
Lunch Box Set rectangular
200 x 130 x 130 mm | 7¾ x 5½ x 5½"



OCR 10-4869-9420
Lunch Box Set round
130 x 130 x 150 mm | 5¼ x 5¼ x 6"



OCR 10-4869-7996
Drinking Bottle mineral
83 mm · 0,55l | 3¼" · 18½ oz.



OCR 10-4869-9410
Lunch Box M round
130 x 130 x 60 mm | 5¼ x 5¼ x 2½"



OCR 10-4869-9411
Lunch Box L mineral
130 x 130 x 95 mm | 5¼ x 5¼ x 3¾"



OCR 10-4869-9412
Lunch Box S rectangular
130 x 100 x 60 mm | 5¼ x 4 x 2½"



OCR 10-4869-9413
Lunch Box S rectangular mineral
130 x 100 x 60 mm | 5¼ x 4 x 2½"



OCR 10-4869-9414
Lunch Box M rectangular
200 x 130 x 60 mm | 7¾ x 5½ x 2½"



OCR 10-4869-9415
Lunch Box L rectangular mineral
200 x 130 x 75 mm | 7¾ x 5½ x 3"



OCR 10-4869-9417
Glass Lunch Box M
130 x 130 x 60 mm | 5¼ x 5¼ x 2½"



OCR 10-4869-9418
Glass Lunch Box L
130 x 130 x 95 mm | 5¼ x 5¼ x 3¾"





COFFEE TO GO

— Collection —

Coffee To Go is the most beautiful declaration of love for the perfect coffee experience - wherever your guests happen to be. With their heat-resistant fabric sleeves, our Coffee To Go mugs are ideal travel companions. They always catch the eye thanks to the stylish decor with modern on-trend colours and hip motifs.

Coffee To Go est la plus belle déclaration d'amour à une dégustation parfaite du café, partout où se trouvent vos clients. Dotés d'une bande en tissu résistant à la chaleur, nos mugs Coffee To Go sont les compagnons parfaits à emporter avec soi. Leurs décors élégants aux couleurs modernes tendance et aux motifs branchés attirent tous les regards.

Coffee To Go ist die schönste Liebeserklärung an einen vollendeten Kaffeegenuss - ganz egal, wo Ihre Gäste gerade sind. Ausgestattet mit einer hitzebeständigen Stoffbanderole, sind unsere Coffee To Go Becher der ideale Begleiter für unterwegs. Die stylischen Dekore in modernen Trendfarben und angesagten Motiven sind ein absoluter Eye-Catcher.

Coffee To Go es la más bella declaración de amor para disfrutar del café a la perfección, sin importar dónde estén sus invitados. Equipadas con una banda textil resistente al calor, nuestras tazas Coffee To Go son ideales para llevar. Las bonitas decoraciones en colores modernos y motivos de moda son un absoluto reclamo.

Coffee To Go è la dichiarazione d'amore più bella al piacere di bere caffè. Non importa dove si trovino i vostri ospiti. Dotate di una fascetta in stoffa resistente al calore, le nostre tazze Coffee To Go sono ideali da portare con sé fuori casa. Gli eleganti decori dai moderni colori di tendenza e i motivi alla moda attirano l'attenzione.



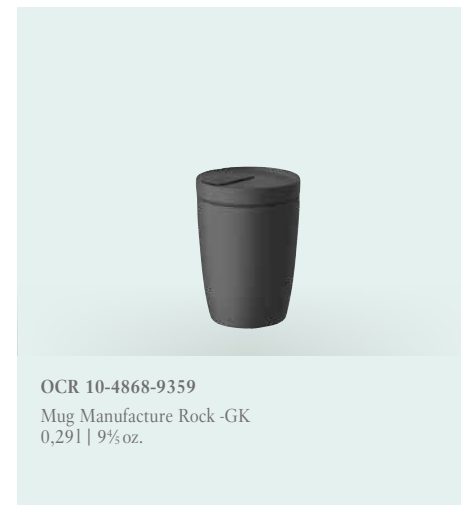
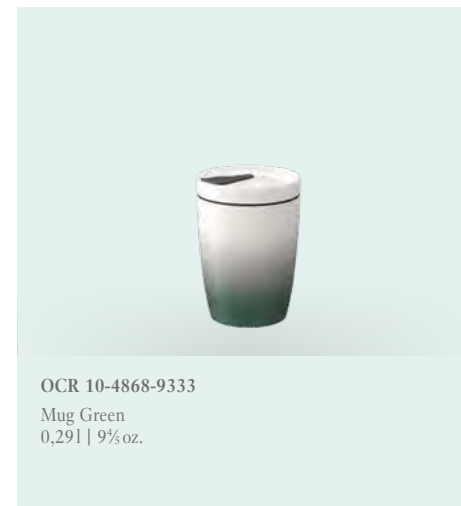
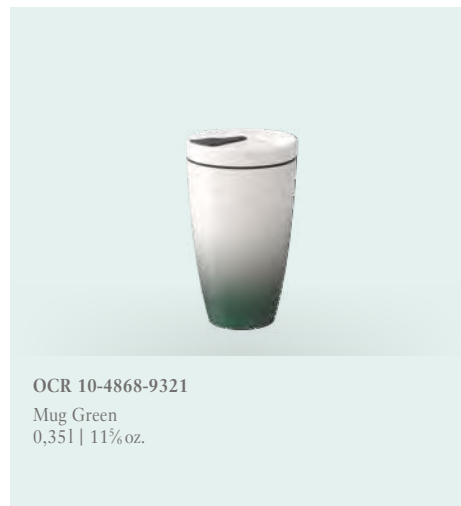
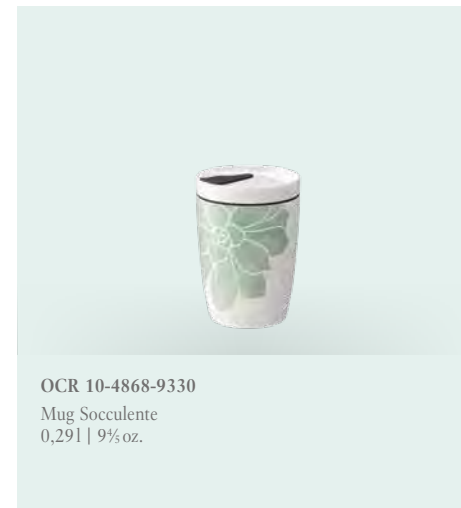



TO GO

— Collection —

Your guests can easily enjoy culinary creations and speciality coffees on the go - with our To Go products. Thanks to the secure seal and practical heat-proof sleeve, our To Go range is very easy to carry.

Avec nos produits To Go, vos clients pourront savourer en toute simplicité des créations culinaires et des spécialités de café, et ce même lors de leurs déplacements. Grâce à une étanchéité parfaite et une bande maintien pratique et thermorésistante, notre gamme To Go se transporte facilement.

Mit unseren To Go Produkten können Ihre Gäste kulinarische Kreationen und Kaffeespezialitäten ganz einfach auch unterwegs genießen. Dank der sicheren Dichtung und dem praktischen, hitzebeständigen Sleeve ist unser To Go Sortiment besonders gut zu transportieren.

Con nuestros productos To Go, sus invitados podrán disfrutar fácilmente de sus creaciones culinarias y especialidades de café en cualquier lugar. Gracias a su cierre seguro y a su práctica funda que resiste el calor, nuestra gama To Go resulta muy sencilla de transportar.

Con i prodotti To Go, darete la possibilità ai vostri ospiti di godersi creazioni culinarie e specialità a base di caffè anche quando sono in giro. Grazie alla chiusura ermetica e al pratico manicotto termico, la nostra gamma To Go è molto comoda da trasportare.







Fine DINING

Our Fine Dining series combine everything that makes Villeroy & Boch so popular worldwide. Besides a striking design, Villeroy & Boch's years of experience, precise artisnry, latest technology and strict quality checks ensure high quality and yield one of the finest porcelains:

Premium Bone Porcelain

Nos séries Fine Dining réunissent ce qui fait la popularité de Villeroy & Boch. Outre un design prodigieux, Villeroy & Boch garantit sa haute qualité par des années d'expérience, un travail artisanal précis, une technologie de pointe et des contrôles qualité stricts, et propose l'une des porcelaines les plus fines :

la Premium Bone Porcelain

Unsere Fine Dining Serien vereinen alles, was die Marke Villeroy & Boch weltweit so beliebt macht. Neben eindrucksvollem Design stellt Villeroy & Boch durch jahrelange Erfahrung, präzises Handwerk, modernste Technik, sowie strenge Qualitätsprüfungen seine hohe Qualität sicher und bietet eines der edelsten Porzellane an:

Premium Bone Porcelain

Le nuove serie Fine Dining uniscono tutto ciò che fa di Villeroy & Boch un marchio apprezzato nel mondo. Oltre al design d'effetto, Villeroy & Boch garantisce l'alta qualità tramite anni di esperienza, lavorazione artigianale, tecnologie all'avanguardia e severi controlli qualità e offre una delle migliori porcellane:

Premium Bone Porcelain

Nuestras series Fine Dining aúnan todo lo que hace tan popular a la marca Villeroy & Boch a nivel mundial. Además de un marcado diseño, Villeroy & Boch garantiza su alta calidad mediante su dilatada experiencia, artesanía precisa, tecnología punta y estrictas pruebas de calidad, y ofrece una de las más finas porcelanas:

Premium Bone Porcelain



Premium

BONE PORCELAIN

Premium Bone Porcelain is considered the finest of all porcelains. Villeroy & Boch Premium Bone Porcelain contains a minimum of 45% calcined bone ash and is of a particularly high quality. This soft-paste porcelain is thin, light to the touch and fascinates with its brilliant white and translucent character, boasting a very high resistance to chipping.

La Premium Bone Porcelain (porcelaine à base d'os) est la porcelaine la plus raffinée. La Premium Bone Porcelain de Villeroy & Boch contient au minimum 45% d'os calcinés pour une porcelaine de la plus haute qualité. Fine et légère, elle fascine par son blanc éclatant, sa translucidité mais aussi son extrême résistance aux ébréchures.

Premium Bone Porcelain (Knochenporzellan) gilt als das edelste aller Porzellane. Premium Bone Porcelain von Villeroy & Boch enthält mindestens 45% kalzinierte Knochenasche und ist von besonders hoher Qualität. Der fühlbar dünne und leichte Scherben fasziniert durch brillantes Weiß, durchscheinende Transparenz und sehr hohe Kantenschlagfestigkeit.

La Premium Bone Porcelain (porcelana ósea) es considerada la más noble de las porcelanas. La Premium Bone Porcelain de Villeroy & Boch contiene al menos un 45% de cenizas óseas calcinadas y es de una calidad muy alta. La pasta fina y ligera fascina con un blanco brillante, una transparencia diáfana y una gran resistencia a los golpes de canto.

La Premium Bone Porcelain (porcellana di ossa animali) è considerata la più preziosa tra le porcellane e quella di Villeroy & Boch è composta per il 45% di cenere d'osso calcinata risultando di qualità pregiata. Il coccio sottile e leggero affascina per la brillantezza del suo bianco, la sua trasparenza e la resistenza degli spigoli alla rottura.





RANGE OVERVIEW

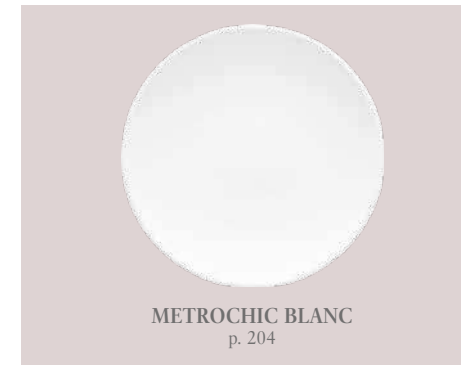
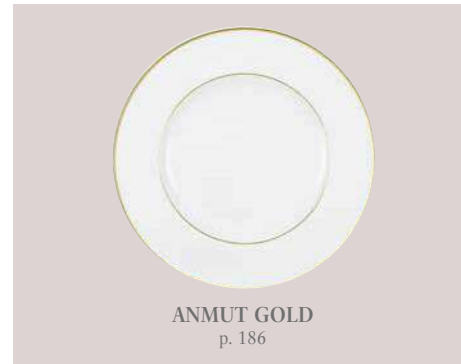



ANMUT GOLD

Collection

Anmut Gold features bright white Premium Bone Porcelain and hand-painted decorative lines made with 20-carat gold. The innovative “Inglaze Gold” technology lets the high-quality decor sink deep into the glaze during the firing process, protecting the fine gold. This creates a timeless classic, which can be stylishly staged.

Anmut Gold séduit par sa Premium Bone Porcelain d'un blanc éclatant et ses lignes décoratives peintes à la main à l'or 20 carats. La technologie innovante «Inglaze Gold» permet à son décor de qualité de pénétrer profondément dans l'émail pendant la cuisson et protège l'or fin. C'est un classique intemporel qui sait se mettre en scène avec style.

Anmut Gold begeistert mit strahlend weißem Premium Bone Porcelain und handgemalten Dekorlinien aus 20 Karat Gold. Die innovative „Inglaze Gold“ Technologie lässt das hochwertige Dekor beim Brand tief in die Glasur einsinken und schützt das edle Gold. So entsteht ein zeitloser Klassiker, der sich stilvoll in Szene setzen lässt.

Anmut Gold destaca con una elegante Premium Bone Porcelain de color blanco y líneas decorativas pintadas a mano con oro de 20 quilates. Sus elementos decorativos de calidad quedan grabados a fuego en el esmalte con la innovadora tecnología “Inglaze Gold”, protegiendo el refinado oro de las piezas. El resultado es un clásico atemporal con estilo.

Anmut Gold convince per la Premium Bone Porcelain in bianco lucido e splendente come pure per i decori dipinti a mano in oro 20 carati. Con l'innovativa tecnologia “Inglaze Gold” il decoro penetra a fondo nello smalto durante la cottura, proteggendo il prezioso oro. Nasce così un classico senza tempo, pronto per essere messo in risalto con stile.

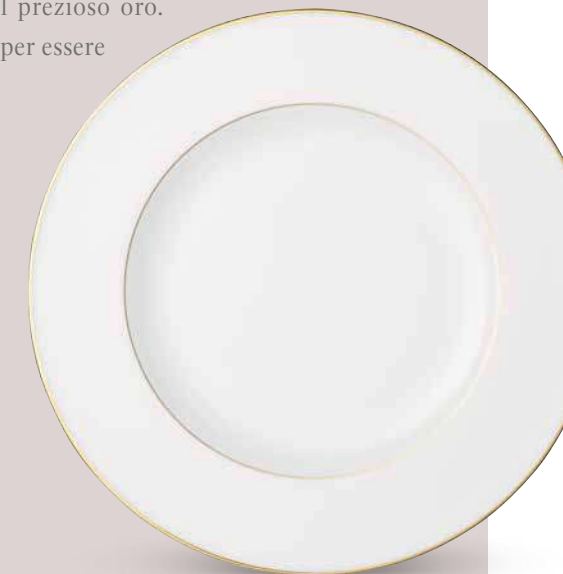

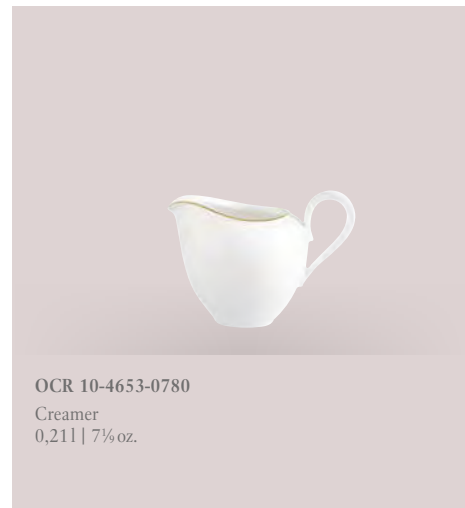

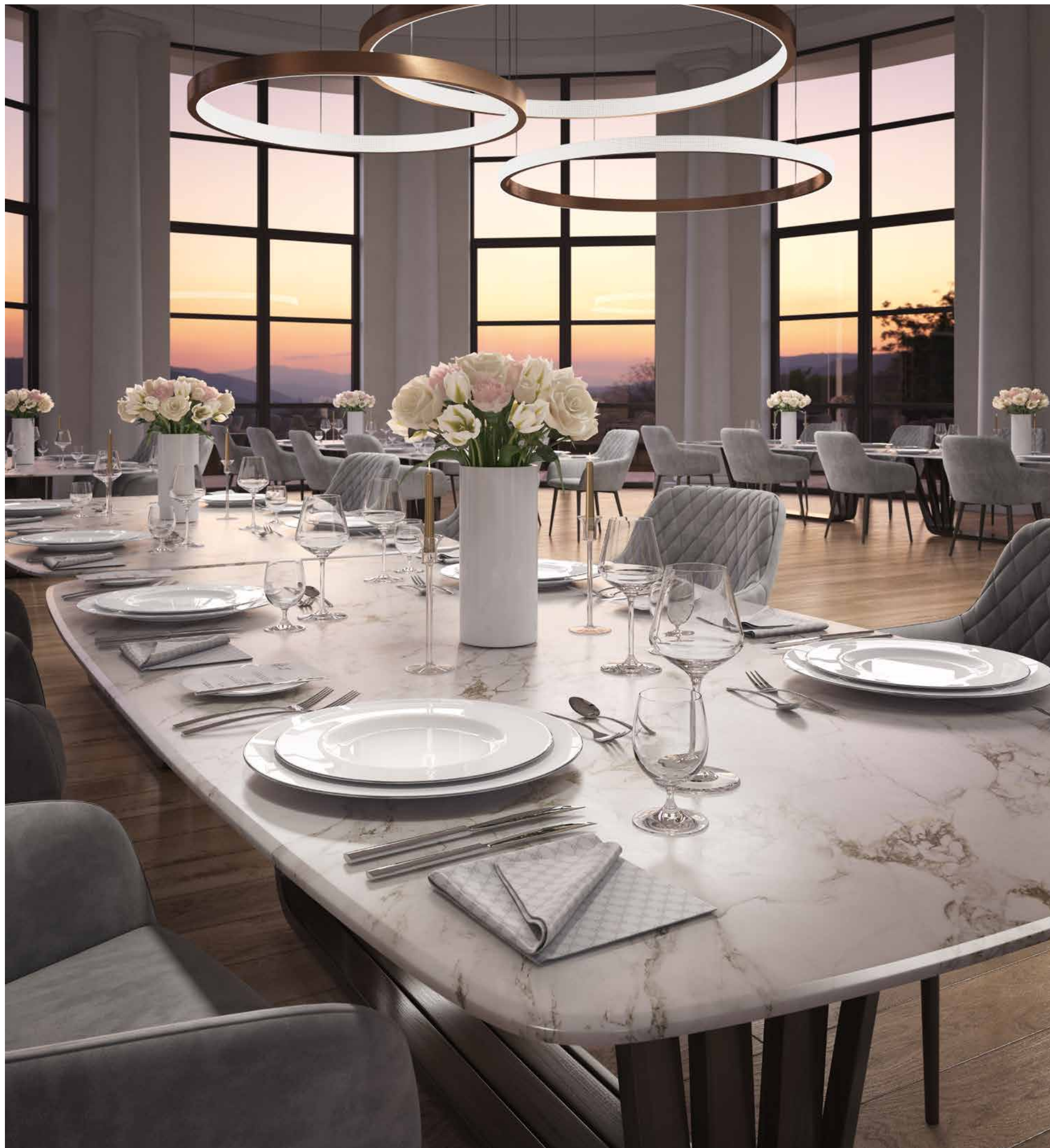

ANMUT PLATINUM

Collection

Anmut Platinum meets the highest standards in terms of materials and design. The collection features the finest of all porcelains: Premium Bone Porcelain. The highlight is the fine decorative platinum lines gracing the edges of this fine material.

Anmut Platinum satisfait aux exigences les plus élevées en termes de matériau et de design. Cette collection séduit avec la plus fine des porcelaines : la Premium Bone Porcelain. Les bords de ce matériau raffiné sont ornés d'une bande en platine toute en filigrane.

Anmut Platinum erfüllt die höchsten Ansprüche an Material und Design. Die Kollektion begeistert mit dem feinsten aller Porzellane: Premium Bone Porcelain. Als Krönung wird dieses edle Material an den Rändern von einem filigranen Platinband eingefasst.

Anmut Platinum está a la altura de las más altas exigencias en material y diseño. Una colección que cautiva por la pureza de su porcelana: Premium Bone Porcelain. Coronando la belleza de sus materiales, los bordes están engastados con una afiligranada línea de platino.

La collezione Anmut Platinum riesce a soddisfare le più elevate esigenze in termini di materiale e design. La collezione conquista con la sua pregiata porcellana: la Premium Bone Porcelain. Questo raffinato materiale è impreziosito da un delicato bordo in platino.





OCR 10-4636-0460
Teapot with cover
1,01 | 33½ oz.



OCR 10-4636-0780
Creamer
0,211 | 7½ oz.



OCR 10-4636-0960
Sugar/jampot 6 pers
0,351 | 11½ oz.



OCR 10-4636-2660
Bread & butter plate
160 mm | 6½"

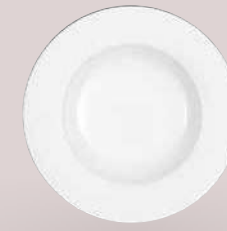

OCR 10-4636-2700
Deep plate
240 mm · 0,31 | 9½" · 10½ oz.



OCR 10-4636-2940
Oval platter
410 mm | 16½"



OCR 10-4636-9651
Mug with handle
0,351 | 11½ oz.



OCR 10-4636-1270
Cup
0,21 | 6¼ oz.



OCR 10-4636-1300
Cup
0,21 | 6¼ oz.



OCR 10-4636-3170
Salad bowl
230 mm | 9"



OCR 10-4636-3810
Individual bowl
130 mm | 5½"



OCR 10-4636-3407
Sauceboat without saucer
0,441 | 14½ oz.



OCR 10-4636-1420
Cup
0,11 | 3½ oz.



OCR 10-4636-1280
Saucer
150 mm | 6"
Ref. 1270, 1300



OCR 10-4636-1430
Saucer
120 mm | 4½"
Ref. 1420



OCR 10-4636-3570
Pickle dish
200 mm | 7½"
Ref. 3407

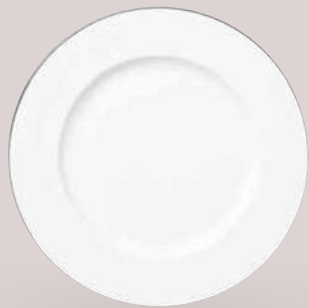

OCR 10-4636-2810
Round platter
330 mm | 13"



OCR 10-4636-2630
Flat plate
280 mm | 11"



OCR 10-4636-2650
Salad plate
220 mm | 8½"



BLOSSOM

— Collection —

Blossom Hotel will inspire with its unique floral design and captivate with its fine elegance. The delicate, purposefully imperfect look and feel of this Premium Bone Porcelain range is achieved through a highly demanding production process.

Blossom Hotel inspire par sa forme florale unique et séduit par son élégance des plus raffinées. Cette série en Premium Bone Porcelain doit sa beauté volontairement imparfaite et délicate à un procédé de fabrication extrêmement rigoureux.

Blossom Hotel inspiriert mit einer einzigartigen floralen Formensprache und besticht zugleich durch feinste Eleganz. Die zarte, absichtlich unvollkommene Anmutung der Premium Bone Porcelain Serie wird durch eine äußerst anspruchsvolle Fertigung erzielt.

Blossom Hotel inspira con un lenguaje floral único y destaca a la vez por su delicada elegancia. El aspecto suave y deliberadamente imperfecto de la serie Premium Bone Porcelain se logra mediante un proceso de fabricación muy exigente.

Blossom Hotel ispira con uno straordinario linguaggio floreale e colpisce con una raffinata eleganza. Volutamente imperfetta, la delicata essenza della serie in Premium Bone Porcelain è merito di una lavorazione oltremodo elaborata.



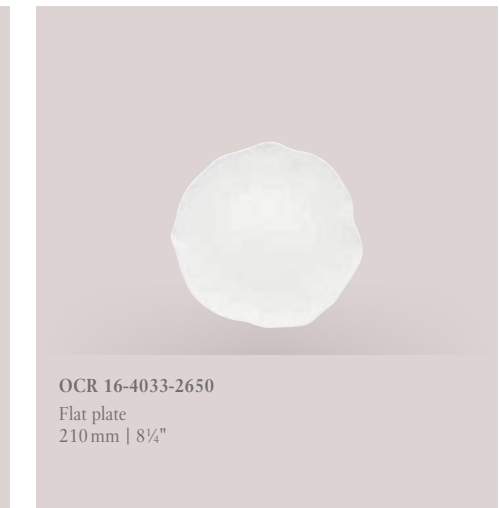



METROCHIC

Collection

MetroChic is a style statement in the classic colours of white, black and gold. This cosmopolitan tableware range boasts a modern geometric decor on fine Premium Bone Porcelain. The hand-polished, 20-carat gold finish is perfectly protected by the innovative “Inglaze Gold” technology.

MetroChic est une véritable déclaration de style dans des tons classiques : blanc, noir et doré. Cette série de vaisselle cosmopolite séduit avec le décor moderne et géométrique ornant sa Premium Bone Porcelain raffinée. Sa finition à l'or 20 carats est polie à la main et parfaitement protégée par la technologie innovante « Inglaze Gold ».

MetroChic ist ein Stilstatement in den klassischen Farben Weiß, Schwarz und Gold. Die kosmopolitische Geschirr-Serie begeistert mit einem modernen, geometrischen Dekor auf edlem Premium Bone Porcelain. Die 20 Karat Gold Veredlung ist handpoliert und durch die innovative „Inglaze Gold“ Technologie besonders gut geschützt.

MetroChic es toda una declaración de estilo engalanada en los clásicos colores blanco, negro y oro. Esta vajilla cosmopolita destaca por una decoración moderna y geométrica sobre Premium Bone Porcelain. El acabado en oro de 20 quilates está pulido a mano y especialmente bien preservado gracias a la innovadora tecnología “Inglaze Gold”.

MetroChic è una dichiarazione di stile nei classici colori bianco, nero e oro. La serie di stoviglie dallo stile cosmopolita stupisce con un decoro moderno e geometrico che impreziosisce una raffinata Premium Bone Porcelain. La finitura in oro 20 carati è lucidata a mano e protetta alla perfezione grazie all'innovativa tecnologia “Inglaze Gold”.





OCR 10-4652-0460
Coffeepot/Teapot with cover
1,21 | 40% oz.



OCR 10-4483-0530
Teapot small
210 x 90 x 105 mm · 0,441 | 8½ x 3½ x 4½" · 14% oz.

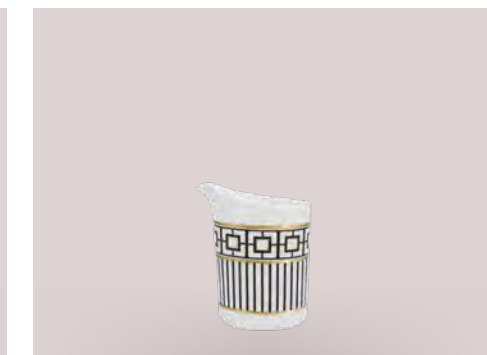

OCR 10-4652-0780
Creamer
0,221 | 7% oz.

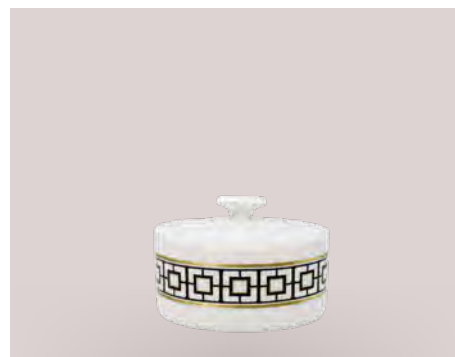

OCR 10-4652-0960
Sugar/jampot 6pers
0,331 | 11% oz.



OCR 10-4483-4855
Mug with lid
115 x 85 x 110 mm · 0,321 | 4½ x 3½ x 4½" · 10% oz.



OCR 10-4652-4856
Mug
110 x 80 x 90 mm · 0,31 | 4½ x 3½ x 3½" · 10% oz.



OCR 10-4652-1270
Cup
0,231 | 7% oz.



OCR 10-4652-1300
Cup
0,211 | 7% oz.



OCR 10-4652-1420
Cup
0,081 | 2% oz.



OCR 10-4483-4892
Tea cup
70 x 70 x 70 mm · 0,151 | 2½ x 2¼ x 2¼" · 5 oz.

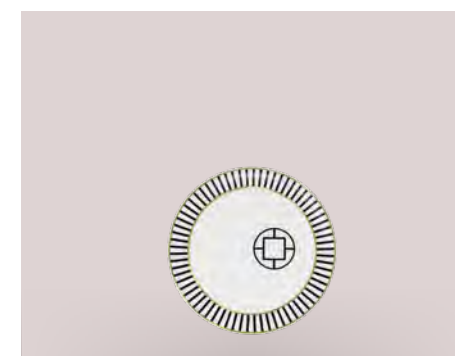

OCR 10-4652-1310
Saucer
185 x 185 x 20 mm | 7½ x 7½ x ½" ·
Ref. 1270, 1300

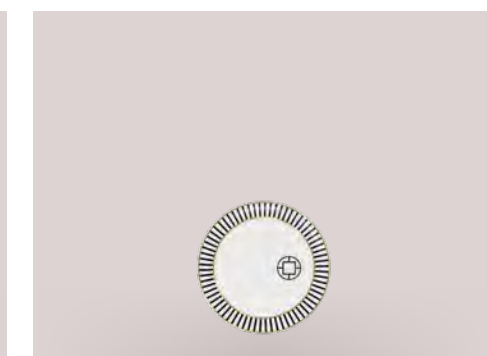

OCR 10-4652-1430
Saucer
145 x 145 x 15 mm | 5½ x 5½ x ½" ·
Ref. 1420



OCR 10-4652-2620
Flat plate
270 x 270 x 20 mm | 10% x 10% x 1/8"

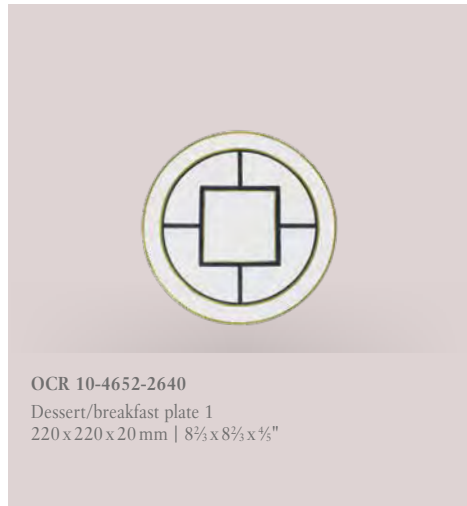

OCR 10-4652-2640
Dessert/breakfast plate 1
220 x 220 x 20 mm | 8 3/4 x 8 3/4 x 1/8"

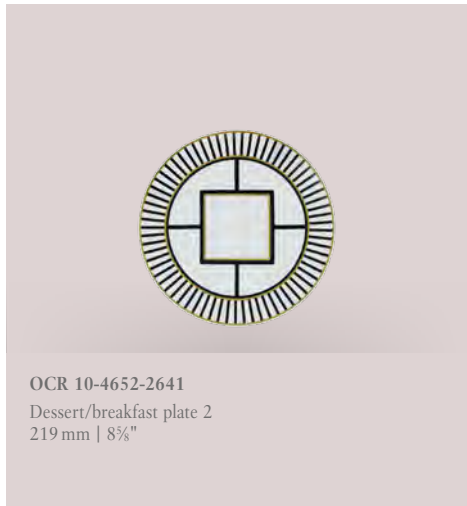

OCR 10-4652-2641
Dessert/breakfast plate 2
219 mm | 8 3/8"

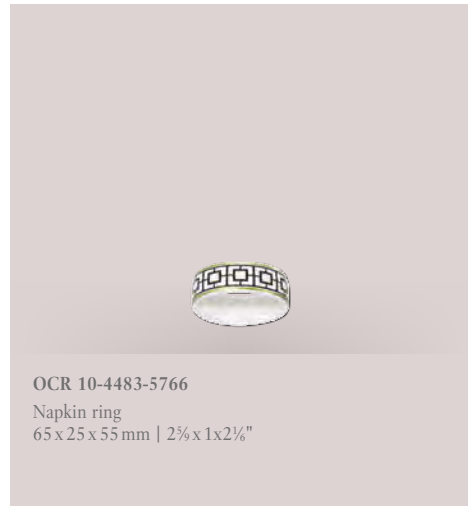

OCR 10-4483-5766
Napkin ring
65 x 25 x 55 mm | 2 1/2 x 1 x 2 1/8"



OCR 10-4483-6072
Serving/Decorative bowl
330 x 330 x 40 mm · 2,51 | 13 x 13 x 1 1/4" · 84 1/2 oz.

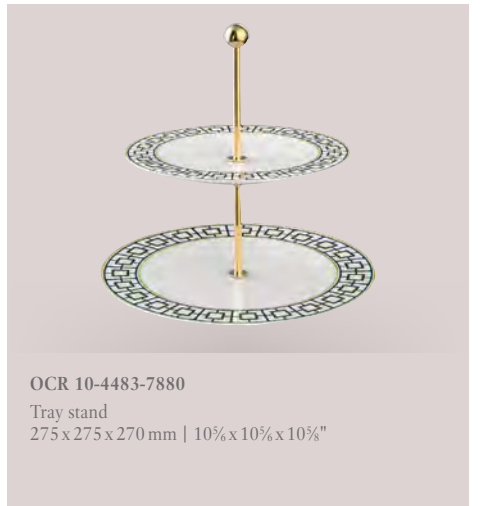

OCR 10-4483-7880
Tray stand
275 x 275 x 270 mm | 10% x 10% x 10%"



OCR 10-4652-2660
Bread & butter plate
160 mm | 6 3/8"



OCR 10-4652-2700
Deep plate
220 x 220 x 50 mm · 0,81 | 8 3/4 x 8 3/4 x 2" · 27 oz.



OCR 10-4652-3170
Salad bowl
230 mm | 9"

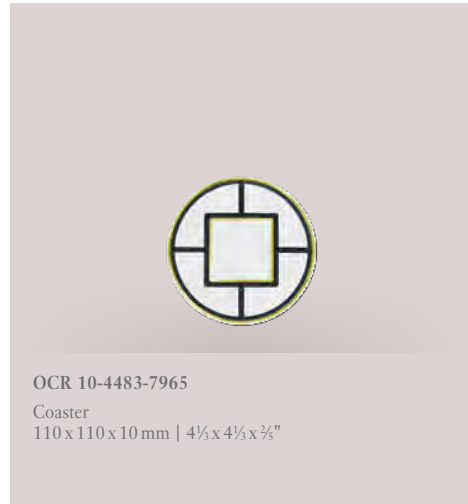

OCR 10-4483-7965
Coaster
110 x 110 x 10 mm | 4 1/2 x 4 1/2 x 3/8"



OCR 10-4483-8230
Porcelain box
160 x 130 x 100 mm · 0,81 | 6 1/2 x 5 1/2 x 4" · 27 oz.



OCR 10-4652-1900
Bowl
150 x 150 x 60 mm · 0,61 | 6 x 6 x 2 1/2" · 20 1/2 oz.



OCR 10-4652-2535
Soup bowl
130 x 130 x 65 mm · 0,481 | 5 1/2 x 5 1/2 x 2 1/2" · 16 1/2 oz.



OCR 10-4652-1905
Rice bowl
110 x 110 x 65 mm · 0,351 | 4 1/2 x 4 1/2 x 2 1/2" · 11 1/2 oz.



OCR 10-4652-2200
Cake plate
330 mm | 13"



OCR 10-4483-5070
Vase tall
130 x 130 x 305 mm · 3,01 | 5 1/2 x 5 1/2 x 12" · 101 oz.



OCR 10-4483-5520
Tea light holder
75 x 75 x 130 mm | 3 x 3 x 5 1/8"



"Inglaze Gold" by Villeroy & Boch is the innovative decor technique to protect particularly fine materials – it preserves the brilliance and shine of fine porcelain.



METROCHIC BLANC

Collection

Pure design meets Villeroy & Boch Premium Bone Porcelain. The timeless and elegant design of MetroChic blanc stylishly blends in with the world of haute cuisine and award-winning starred restaurants. The collection excites with contemporary coupe shapes, which act as an expressive stage for showcasing exceptional food creations.

L'alliance d'un design épuré et de la Premium Bone Porcelain Villeroy & Boch. Le design élégant et intemporel de MetroChic blanc s'intègre avec style à l'univers de la haute gastronomie et des restaurants étoilés primés. Cette collection séduit par ses formes coupes contemporaines pour la mise en scène de créations culinaires exceptionnelles.

Pures Design trifft auf Villeroy & Boch Premium Bone Porcelain. Das zeitlose, elegante Design von MetroChic blanc fügt sich stilvoll in die Welt der Haute Cuisine und prämiierter Sternerestaurants ein. Die Kollektion begeistert mit zeitgemäßen Coup Formen, die außergewöhnliche Foodkreationen ausdrucksstark in Szene setzen.

Diseño puro en Premium Bone Porcelain de Villeroy & Boch. El diseño elegante y atemporal de MetroChic blanc se integra con estilo en el mundo de la haute cuisine y de los mejores restaurantes. Esta colección cautiva por sus modernas formas coupé, que ayudan a poner en escena con expresividad las mejores creaciones culinarias.

Il design puro incontra la Premium Bone Porcelain di Villeroy & Boch. Il design elegante e intramontabile di MetroChic blanc si inserisce con raffinatezza nel mondo della haute cuisine e dei ristoranti stellati. La collezione conquista per la contemporaneità delle forme coup, capaci di presentare con grande effetto straordinarie creazioni culinarie.







MODERN GRACE

Collection

Modern Grace is inspired by the geometric furniture style of the 1930s and 1950s. The exceptional diversity of shapes - from strictly geometric cups to angular plates with gently curving rims and decorative oval bowls - creates endless combination possibilities for your very own arrangements.

Modern Grace s'inspire du design du mobilier des années 30 et 50 et de ses formes géométriques. L'extraordinaire variété de formes, des tasses à la géométrie stricte aux assiettes rectangulaires aux bords légèrement incurvés, en passant par les délicats bols ovales, crée des possibilités de combinaisons infinies pour vos compositions personnelles.

Modern Grace ist inspiriert vom geometrischen Möbeldesign der 1930er und 1950er Jahre. Die außergewöhnliche Formenvielfalt aus streng geometrischen Tassen, rechteckigen Tellern mit sanft geschwungenem Rand und zierlichen, ovalen Schalen schafft endlos viele Kombinationsmöglichkeiten für Ihr ganz individuelles Arrangement.

Modern Grace se inspira en el geométrico diseño de muebles de los años 30 y 50 del siglo pasado. La extraordinaria variedad de formas, desde tazas estrictamente geométricas, platos rectangulares con bordes suavemente curvados y delicados cuencos ovalados, crea un sinfín de posibilidades de combinación para su propio arreglo individual.

Modern Grace si ispira al design geometrico dei mobili degli anni '30 e '50. La straordinaria varietà di forme che spazia da tazze rigorosamente geometriche, piatti rettangolari con bordi delicatamente curvi e a graziose ciotole ovali crea un numero infinito di combinazioni possibili per i vostri personali impiattamenti.





OCR 10-4510-0460
 Coffeepot/Teapot with cover
 1,21 | 40½ oz.

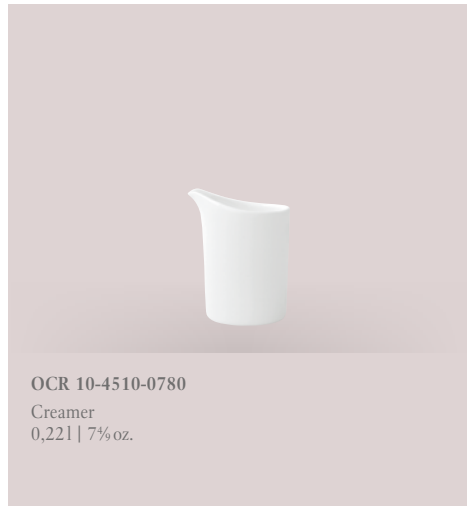

OCR 10-4510-0780
 Creamer
 0,221 | 7½ oz.



OCR 10-4510-0960
 Sugar bowl with cover
 0,331 | 11½ oz.



OCR 10-4510-2660
 Flat plate
 160 x 160 mm | 6½ x 6½"



OCR 10-4510-2772
 Flat rectangular plate
 240 x 140 mm | 9½ x 5½"



OCR 10-4510-2700
 Deep plate
 240 x 210 mm · 0,271 | 9½ x 8¼" · 9½ oz.



OCR 10-4510-1270
 Cup
 0,231 | 7½ oz.



OCR 10-4510-1300
 Cup
 0,221 | 7½ oz.



OCR 10-4510-1420
 Cup
 0,081 | 2½ oz.



OCR 10-4510-2680
 Buffet plate
 350 x 350 mm | 13¾ x 13¾"



OCR 10-4510-2580
 Serving dish
 440 x 230 mm | 17½ x 9"



OCR 10-4510-2581
 Serving dish
 350 x 180 mm | 13¾ x 7"



OCR 10-4510-1280
 Saucer
 170 x 140 mm | 6½ x 5½"
Ref. 1270



OCR 10-4510-1310
 Saucer
 170 x 140 mm | 6½ x 5½"
Ref. 1300

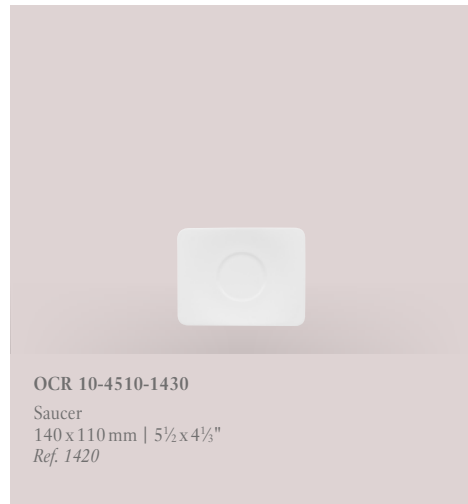

OCR 10-4510-1430
 Saucer
 140 x 110 mm | 5½ x 4½"
Ref. 1420



OCR 10-4510-3287
 Oval bowl
 380 x 220 mm · 3,01 | 15 x 8¾" · 101½ oz.



OCR 10-4510-3288
 Oval bowl
 300 x 180 mm · 1,31 | 11½ x 7" · 44 oz.



OCR 10-4510-2535
 Oval pickle dish
 190 x 120 mm · 0,451 | 7½ x 4¾" · 15½ oz.



OCR 10-4510-2600
 Flat plate
 310 x 310 mm | 12½ x 12½"



OCR 10-4510-2610
 Flat plate
 270 x 270 mm | 10½ x 10½"



OCR 10-4510-2640
 Flat plate
 230 x 230 mm | 9 x 9"



OCR 10-4510-3895
 Oval bowl
 290 x 70 mm · 0,31 | 11½ x 2¾" · 10½ oz.



OCR 10-4510-3932
 Dip bowl
 70 x 60 mm · 0,041 | 2¾ x 2½" · 1½ oz.



STELLA HOTEL

Collection

Stella Hotel combines excellent design with professional serviceability. The fine decor made of the finest Premium Bone Porcelain looks resplendent on particularly refined occasions and presents impressive delicacies from talented star chefs with style and charm.

Stella Hotel associe un design d'exception et une aptitude à l'utilisation professionnelle. Son décor noble en Premium Bone Porcelain des plus raffinés brille lors d'occasions particulièrement nobles et présente avec style et charme les mets impressionnants de grands chefs talentueux.

Stella Hotel vereint exzellentes Design mit professioneller Gebrauchstüchtigkeit. Das noble Dekor aus feinstem Premium Bone Porcelain brilliert zu besonders edlen Anlässen und präsentiert eindrucksvolle Delikatessen talentierter Spitzenköche und Spitzenköchinnen mit Stil und Charme.

Stella Hotel combina un excelente diseño con una funcionalidad profesional. La elegante decoración hecha de Premium Bone Porcelain brilla en las ocasiones especialmente nobles y presenta con estilo y encanto las impresionantes delicias de los mejores chefs.

Stella Hotel combina un design eccellente con la versatilità d'uso professionale. Il decoro ricercato in finissima Premium Bone Porcelain si distingue in occasioni particolarmente raffinate e presenta prelibatezze impressionanti di talentuosi chef di alto livello con stile e fascino.





OCR 16-3272-0220
Coffeepot N.7 with cover
0,31 | 10½ oz.



OCR 16-3272-0461
Teapot with cover
1,01 | 33½ oz.



OCR 16-3272-0630
Teapot w. cover/filter
0,41 | 13½ oz.
Ref. 16-2040-7341



OCR 16-3272-1270
Cup
0,261 | 8½ oz.



OCR 16-3272-1300
Cup N.3
0,21 | 6¼ oz.



OCR 16-3272-1420
Cup N.5
0,11 | 3½ oz.



OCR 16-3272-0530
Teapot N.5 with cover
0,41 | 13½ oz.



OCR 16-3272-0781
Creamer
0,21 | 6¼ oz.



OCR 16-3272-0780
Creamer N.4
0,251 | 8½ oz.



OCR 16-3272-1455
Unhandled demitasse
0,11 | 3½ oz.



OCR 16-3272-9651
Mug with handle
0,351 | 11½ oz.



OCR 16-3272-1271
Cup N.2 stackable
0,221 | 7½ oz.



OCR 16-3272-0800
Creamer N.6
0,11 | 3½ oz.



OCR 16-3272-0961
Sugar bowl with cover
0,351 | 11½ oz.



OCR 16-3272-0960
Sugar bowl with cover
0,351 | 11½ oz.



OCR 16-3272-1361
Cup N.4 stackable
0,181 | 6 oz.



OCR 16-3272-1451
Cup N.8 stackable
0,11 | 3½ oz.



OCR 16-3272-2510
Soup cup
0,41 | 13½ oz.



OCR 16-3272-0930
Sugar bowl with cover
0,151 | 5 oz.



OCR 16-3272-1273
Cup
0,21 | 6¼ oz.



OCR 16-3272-1240
Cup N.1
0,41 | 13½ oz.



OCR 16-3272-2513
Soup cup stackable
0,271 | 9½ oz.



OCR 16-3272-2514
Unhandled soup cup stackable
0,281 | 9½ oz.



OCR 16-3272-1281
Saucer
150 mm | 6"
Ref. 1273



OCR 16-3272-2522
Saucer soup cup
180 mm | 7"
Ref. 2513, 2514



OCR 16-3272-1280
Saucer
150 mm | 6"
Ref. 1271, 1361, 3911



OCR 16-3272-1460
Saucer
120 mm | 4½"
Ref. 1451, 1455



OCR 16-3272-2661
Flat coupe plate
160 mm | 6½"



OCR 16-3272-2795
Flat plate
290 x 140 mm | 11½ x 5½"



OCR 16-3272-2796
Flat plate
290 x 180 mm | 11½ x 7"



OCR 16-3272-1250
Saucer
175 mm | 6½"
Ref. 1240, 3810, 9651



OCR 16-3272-2520
Saucer soup cup
175 mm | 6½"
Ref. 2510



OCR 16-3272-1310
Saucer
150 mm | 6"
Ref. 1270, 1300



OCR 16-3272-2701
Deep plate
290 x 140 mm · 0,311 | 11½ x 5½" · 10½ oz.



OCR 16-3272-2790
Deep plate
290 mm · 0,51 | 11½" · 17 oz.



OCR 16-3272-2700
Deep plate
240 mm · 0,331 | 9½" · 11½ oz.



OCR 16-3272-1430
Saucer
120 mm | 4½"
Ref. 1420, 3921

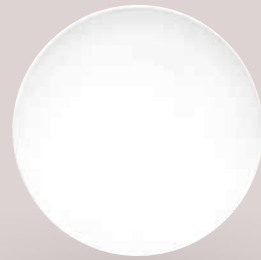

OCR 16-3272-2595
Flat coupe plate
330 mm | 13"



OCR 16-3272-2601
Flat coupe plate
290 mm | 11½"



OCR 16-3272-2940
Oval platter
410 x 290 mm | 16½ x 11½"



OCR 16-3272-2960
Oval platter
340 x 230 mm | 13½ x 9"



OCR 16-3272-2600
Flat plate
290 mm | 11½"



OCR 16-3272-2620
Flat coupe plate
270 x 270 x 20 mm | 10½ x 10½ x ¾"



OCR 16-3272-2641
Flat coupe plate
250 mm | 9½"



OCR 16-3272-2651
Flat coupe plate
210 mm | 8¼"



OCR 16-3272-2630
Flat plate
280 mm | 11"



OCR 16-3272-2640
Flat plate
240 mm | 9½"



OCR 16-3272-2650
Flat plate
220 mm | 8½"





OCR 16-3272-3902
Cover bowl/plate
150 mm | 6"



OCR 16-3272-3815
Cover bowl/plate
130 mm | 5 1/8"



OCR 16-3272-3912
Cover bowl/plate
110 mm | 4 1/8"



OCR 16-3272-5501
Spoon
100 mm | 4"



OCR 16-3272-5763
Chopstick & spoon rest
100 mm | 4"



OCR 16-3272-1900
Footed individual bowl
0,61 | 20 3/8 oz.



OCR 16-3272-3922
Cover bowl/plate
90 mm | 3 1/2"



OCR 16-3272-5981
Cover bowl/plate
70 mm | 2 3/4"



OCR 16-3272-5983
Cover bowl/plate
60 mm | 2 1/8"
Ref. 1420, 1451, 1455



OCR 16-3272-3380
Half deep coupe plate
280 mm | 11"



OCR 16-3272-3381
Half deep coupe plate
225 mm | 8 7/8"



OCR 16-3272-3932
Footed individual bowl
80 mm · 0,071 | 3 1/8" · 2 3/8 oz.



OCR 16-3272-3596
Amuse-bouche
160 x 110 mm | 6 1/2 x 4 1/8"



OCR 16-3272-3435
Sauceboat
150 x 60 mm · 0,11 | 6 x 2 1/8" · 3 3/8 oz.



OCR 16-3272-1951
Egg cup with integral saucer
125 mm | 5"

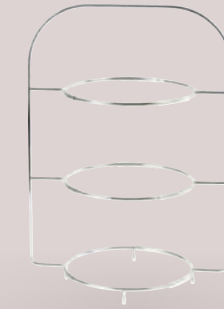

OCR 16-3272-7865
Etagere
Ref. Round plates Ø 21 cm - 29 cm



OCR 16-3272-4890
Unhandled mug/Tea filter holder
0,221 | 7 3/8 oz.



OCR 16-3272-1945
Individual bowl
110 mm · 0,291 | 4 1/8" · 9 1/8 oz.



OCR 16-3272-1946
Individual bowl
110 mm · 0,261 | 4 1/8" · 8 3/8 oz.



STELLA COSMO

Collection

Stella Cosmo guarantees a stylish appearance. The exquisite decor features a unique design and is the perfect complement to the stylish design of Stella Hotel and Stella Vogue. As a delicate style statement, Stella Cosmo works as a culinary stage on which enjoyable dishes perfectly come into their own.

Stella Cosmo est la garantie d'une présentation soignée. Son décor extrêmement élégant séduit par son esthétique et complète ainsi parfaitement le design chic au style affirmé de Stella Hotel et Stella Vogue. Déclaration de style en filigrane, Stella Cosmo offre une toile de fond culinaire sur laquelle de délicieux mets seront mis en valeur.

Stella Cosmo ist der Garant für einen stilvollen Auftritt. Das hochfeine Dekor überzeugt mit seiner Formensprache und ist die perfekte Ergänzung zu dem stilsicheren Design von Stella Hotel und Stella Vogue. Als filigranes Stilstatement fungiert Stella Cosmo als kulinarische Bühne, auf der genussvolle Speisen perfekt zur Geltung kommen.

Stella Cosmo es sinónimo de una puesta en escena elegante. Esta refinada serie asombra con su lenguaje de formas y es el complemento perfecto para Stella Hotel y Stella Vogue. Como una delicada declaración de estilo, Stella Cosmo es el escenario culinario perfecto para platos exquisitos.

Stella Cosmo è garanzia di un aspetto elegante. Il bellissimo decoro convince con il suo linguaggio formale, completando alla perfezione il design raffinato di Stella Hotel e Stella Vogue. Come una raffinata dichiarazione di stile, Stella Cosmo funge da palcoscenico per presentare al meglio gustosi piatti.





OCR 16-4090-1310
Saucer
185 x 185 x 20 mm | 7½ x 7½ x ¾"
Ref. 10-4510-1270, 1300



OCR 16-4090-1430
Saucer
145 x 145 x 15 mm | 5½ x 5½ x ¾"
Ref. 16-3272-1451, 10-4510-1420



OCR 16-4090-2692
Half deep oval coupe plate
340 x 225 x 55 mm | 13½ x 8¾ x 2¼"



OCR 16-4090-4835
Cover
160 x 160 x 160 mm | 6½ x 6½ x 6½"



OCR 16-4090-4836
Cover
120 x 120 x 130 mm | 4¾ x 4¾ x 5½"



OCR 16-4090-2765
Half deep oval coupe plate
300 x 200 x 50 mm | 11½ x 7¾ x 2"



OCR 16-4090-2598
Flat oval coupe plate
340 x 225 x 20 mm | 13½ x 8¾ x ¾"



OCR 16-4090-2731
Flat oval coupe plate
260 x 180 x 20 mm | 10¼ x 7¾"



OCR 16-4090-2645
Flat plate oval mirror
290 x 290 x 20 mm | 11½ x 11½ x ¾"



OCR 16-4090-2706
Deep plate
250 x 250 x 45 mm · 0,121 | 9¾ x 9¾ x 1¾" · 4 oz.



OCR 16-4090-2632
Flat plate
250 x 250 x 30 mm | 9¾ x 9¾ x 1¼"



OCR 16-4090-2701
Deep coupe plate
290 x 290 x 60 mm · 1,21 | 11½ x 11½ x 2½" · 40½ oz.



OCR 16-4090-3470
Salt shaker
60 x 60 x 70 mm · 0,091 | 2½ x 2½ x 2¾" · 3 oz.



OCR 16-4090-3480
Pepper shaker
60 x 60 x 70 mm · 0,091 | 2½ x 2½ x 2¾" · 3 oz.





STELLA VOGUE

Collection

The reduced white-on-white design of Stella Vogue, finished with subtle highlights in sophisticated matte gold, creates a graceful, elegant atmosphere on grand dining tables. The fine decor underscores the glamour and flair of major banquets. Stella Vogue also gives a stylish attitude to upscale fine dining and high-class buffets.

Le décor épuré blanc sur blanc de Stella Vogue, rehaussé de discrets ornements en doré mat élégant, confère grâce et noblesse à toutes les grandes tables. Son décor raffiné souligne le glamour et le charme des grands banquets. Stella Vogue saura également créer une ambiance élégante pour des repas gastronomiques raffinés et des buffets prestigieux.

Das reduzierte Weiß-in-Weiß Dekor von Stella Vogue, ergänzt um dezente Highlights in edlem Mattgold, verleiht jeder großen Tafel Anmut und Noblesse. Das feine Dekor unterstreicht den Glamour und das Flair der großen Bankette. Ebenso verleiht Stella Vogue dem gehobenen Fine Dining oder dem anspruchsvollen Buffet eine stilvolle Attitüde.

La decoración en blanco sobre blanco de Stella Vogue, con sutiles detalles en oro mate, destila gracia y elegancia. La fina decoración realza el glamur y el estilo de los grandes banquetes. Stella Vogue enmarca distinguidamente las creaciones de la mejor cocina y crea una atmósfera especial en bufés en los que una cuidada presentación lo es todo.

Il sobrio decoro bianco su bianco, arricchito da discreti accenti in nobile oro opaco, conferisce grazia e ricercatezza a ogni tavola. Il raffinato decoro sottolinea il fascino e l'atmosfera dei grandi banchetti. Stella Vogue dona un tocco speciale anche al Fine Dining di livello o al buffet più raffinato.







Cutlery

Premium materials, attractive designs, the best craftsmanship – it goes without saying that Villeroy & Boch delivers first-class cutlery. Our stainless steel cutlery series are ideal for professional use in the gastronomy sector.

Des matériaux haut de gamme, un design séduisant et une finition parfaite caractérisent naturellement la qualité supérieure des couverts de table Villeroy & Boch. Nos séries de couverts de table en acier inoxydable sont parfaitement adaptées à un usage professionnel dans le secteur de la restauration.

Hochwertiges Material, attraktives Design, beste Verarbeitung – selbstverständlich, dass Villeroy & Boch erstklassige Besteckqualität liefert. Unsere Besteckserien in Edelstahl sind perfekt geeignet für den professionellen Einsatz in der Gastronomie.

Material de alta calidad, diseño atractivo, el mejor acabado: no hace falta decir que Villeroy & Boch ofrece una cubertería de la máxima calidad. Nuestras series de cubiertos de acero inoxidable son perfectamente adecuadas para un uso profesional en el sector de la restauración.

Materiale di alta qualità, design accattivante, lavorazione eccellente: è ovvio che Villeroy & Boch fornisce posate di prima classe. Le nostre serie di posate in acciaio inossidabile sono perfettamente adatte per l'uso professionale nel settore della ristorazione.





RANGE OVERVIEW



BLACKSMITH
p. 234



BOURGOGNE
p. 238



COUPOLE
p. 242



KREUZBAND
p. 246



NEWWAVE
p. 250



OSCAR
p. 254



PIEMONT
p. 258



UDINE
p. 262



VICTOR
p. 266



BLACKSMITH

— Collection —

An expressive cutlery set with a hammered-finish look: the rustic style of Blacksmith is the perfect complement to reduced Premium Porcelain and lends character to any table setting.

Un aspect martelé pour des couverts de table extrêmement expressifs: le look rustique de Blacksmith est le complément parfait d'une Premium Porcelain épurée et confère à chaque table une touche pleine de caractère.

Ein ausdrucksstarkes Besteck in Hammerschlagoptik: Der rustikale Look von Blacksmith ist die perfekte Ergänzung zu reduziertem Premium Porcelain und verleiht jeder gedeckten Tafel einen besonders charaktervollen Akzent.

Una expresiva cubertería de estética martillada: el aspecto rústico de Blacksmith es el complemento perfecto para la Premium Porcelain y aporta un toque de mucho carácter en cualquier mesa.

Posate fortemente espressive con effetto martellato: L'aspetto rustico di Blacksmith è il complemento perfetto per la sobria Premium Porcelain e conferisce a ogni tavola un accento particolarmente caratteristico.







BOURGOGNE

Collection

The Bourgogne cutlery series impresses with a classic thread pattern, which culminates in a visual and haptic experience. The beautifully designed series impressively harmonises with a wide range of dinnerware series.

La série de couverts de table Bourgogne séduit par son contour décoratif classique offrant une expérience optique et tactile à la fois. Cette série aux jolies formes se marie harmonieusement et de manière impressionnante avec les séries de vaisselle les plus diverses.

Die Besteckserie Bourgogne besticht durch ein klassisches Fadenmuster, das zu einem optischen und haptischen Erlebnis avanciert. Die formschöne Serie harmoniert eindrucksvoll mit den unterschiedlichsten Geschirrsereien.

La serie de cubiertos Bourgogne impresiona con un patrón clásico de hilo que se convierte en una experiencia visual y táctil. Esta bella serie se combina de una manera impresionante con las más diversas series de vajillas.

La serie di posate Bourgogne convince per un classico motivo filettato che si trasforma in un'esperienza visiva e tattile. L'elegante serie si armonizza in modo impressionante con le più svariate linee di stoviglie.



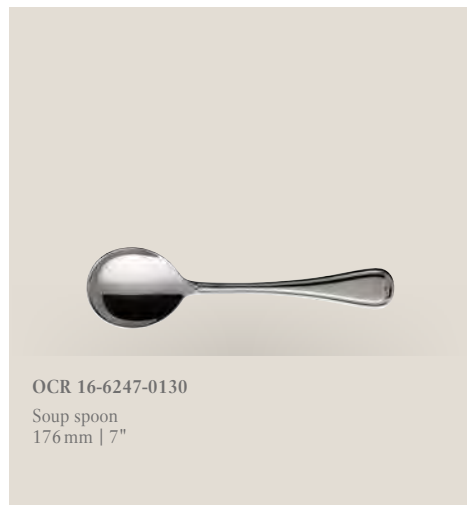
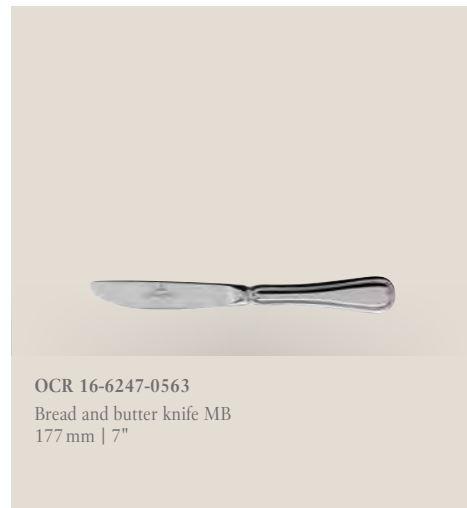



COUPOLE

— Collection —

Coupole combines stylish round and angular shapes. The accentuated lines in the “baguette style” look modern and metropolitan – the perfect companion to dinnerware series with an urban flair. The impressive cutlery series made of the finest stainless steel is absolutely en vogue and, thanks to the high-quality material, is also particularly durable.

Coupole associe des formes arrondies et angulaires élégantes. Ses lignes accentuées par le « style baguette » sont modernes et métropolitaines, elle est parfaite pour accompagner de la vaisselle à l’allure urbaine. Cette impressionnante série de couverts en acier inoxydable de haute qualité est à la fois tendance et particulièrement résistante.

Coupole vereint stilvoll runde und eckigen Formen. Die akzentuierte Linienführung im „Baguette-Stil“ wirkt besonders modern und metropol – der perfekte Begleiter für Geschirrserien mit urbanem Flair. Die eindrucksvolle Besteckserie aus feinstem Edelstahl ist absolut en vogue und dank des hochwertigen Materials zugleich besonders widerstandsfähig.

Coupole combina con estilo formas redondas y angulares. Las líneas acentuadas en estilo “baguette” tienen un efecto moderno y metropolitano: perfecto para vajillas con encanto urbano. La impresionante serie de cubiertos fabricados con el mejor acero inoxidable tiene un estilo a la moda y es muy resistente gracias al material de alta calidad.

Coupole combina elegantemente forme rotonde e angolari. Le linee accentuate nello “stile baguette” risultano moderne e metropolitane: il completamente perfetto per le serie di stoviglie con un tocco urbano. La serie di posate realizzate con il miglior acciaio inossidabile è molto in voga e, grazie al materiale di alta qualità, anche resistente.



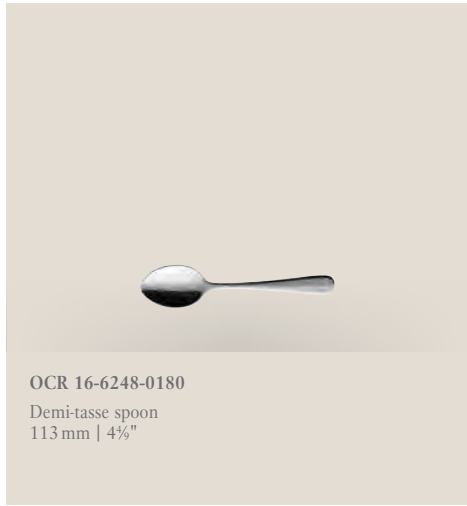
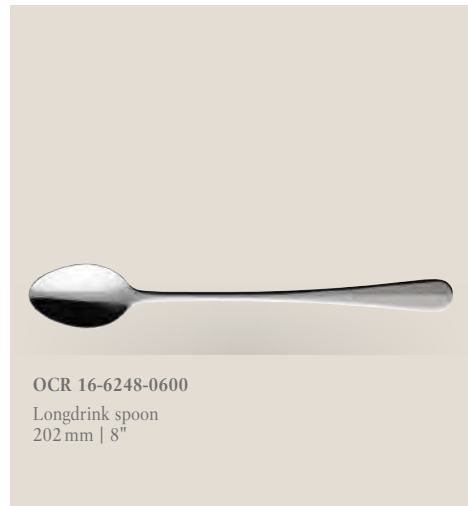

Universal 18/10

Universal 18/10



KREUZBAND

Collection

Delicately crafted reliefs and a traditional design give the fine Kreuzband collection a classically elegant touch. The table cutlery has a rounded shape with delicate plaited chasing on the outer rim. It lies pleasantly in the palm of your hand and is ideal for tasteful occasions.

Un relief finement travaillé et une forme traditionnelle confèrent à la collection raffinée Kreuzband une note classique et élégante. Ces couverts de table de forme arrondie possèdent des ciselures rappelant une tresse fine sur leur bordure extérieure. Ils tiennent confortablement dans la main et conviennent aux occasions synonymes de bon goût.

Fein herausgearbeitete Reliefs und eine traditionelle Formensprache verleihen der edlen Kollektion Kreuzband eine klassisch elegante Note. Das Tafelbesteck hat eine abgerundete Form und besitzt fein herausgearbeitete Flecht-Ziselierungen am äußeren Rand. Es liegt angenehm in der Handfläche und eignet sich besonders für geschmackvolle Anlässe.

Los relieves finamente elaborados y un diseño tradicional le otorgan a la noble colección Kreuzband una nota clásica y elegante. Esta cubertería se caracteriza por sus formas curvas y un cincelado en el borde exterior. Los cubiertos se sostienen cómodamente en la mano y son adecuados para ocasiones donde reine el buen gusto.

Rilievi lavorati finemente e un linguaggio formale tradizionale conferiscono alla collezione Kreuzband un tocco classico ed elegante. Il servizio di posate ha una forma arrotondata e cesellature intrecciate, finemente elaborate decoranti il bordo esterno. Si tiene comodamente nel palmo della mano ed è adatto per occasioni all'insegna del gusto.



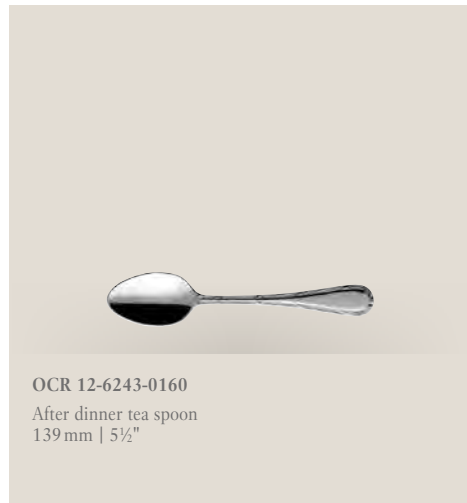



NEWWAVE

— Collection —

Designed to coordinate with the successful porcelain series, this cutlery has a modern and elegant feel. NewWave cutlery impresses with its flowing asymmetric shapes and a table knife with a twisted handle. When combined with the spirited shapes of the NewWave porcelain the effect is particularly impressive.

Ces couverts de table assortis au design exceptionnel de la série de porcelaine du même nom sont modernes et élégants. Ces couverts de table NewWave se caractérisent par l'asymétrie galbée de leurs formes et par leurs couteaux formant une vrille. Cette série est particulièrement spectaculaire combinée aux formes ondulées de la porcelaine NewWave.

Modern und elegant erscheint das passend zum Erfolgsdesign der Porzellanserie entwickelte Besteck. NewWave Besteck besticht durch die geschwungene Asymmetrie des Formdesigns und das in seiner Achse verdrehte Tafelmesser. Besonders eindrucksvoll wirkt die Serie in Kombination mit den schwungvollen Formen des NewWave Porzellans.

Moderna y elegante se presenta la cubertería diseñada en armonía con el exitoso diseño de la serie de porcelana. La cubertería NewWave impresiona por la asimetría sinuosa de sus formas y por los cuchillos de mesa con eje torcido. La serie resulta especialmente impresionante en combinación con las dinámicas formas de la porcelana NewWave.

Le posate, studiate per essere abbinare al design di successo della serie di porcellane, risultano moderne ed eleganti. Le posate NewWave si distinguono per la sinuosa asimmetria del design e il coltello da tavola dall'asse ritorto. La serie risulta particolarmente d'effetto in combinazione con le forme vivaci della porcellana NewWave.



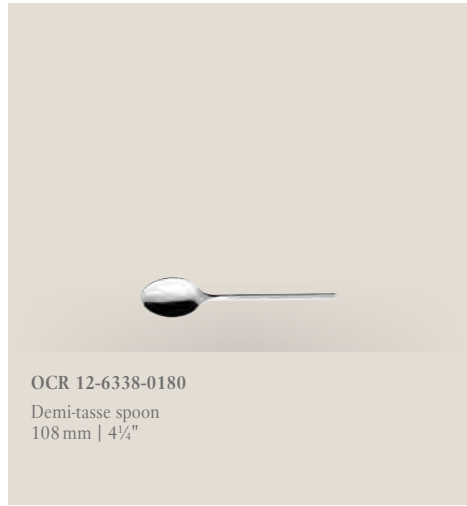
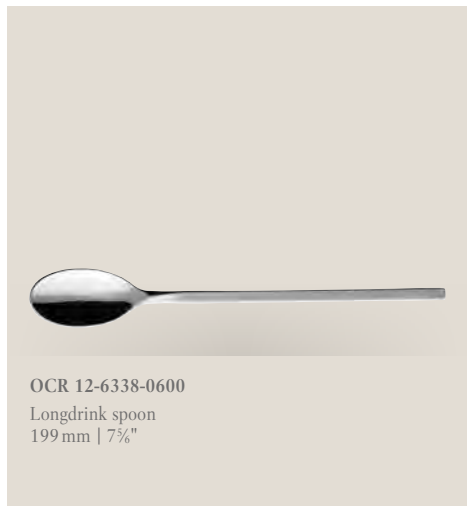



OSCAR

— Collection —

The table cutlery in the Oscar collection impresses with its gently rounded shapes, timelessly simple lines and subtle embossing on the knife handle. Thanks to its universal design, the cutlery is very easy to combine with any Villeroy & Boch tableware collection.

Les couverts de table de la collection Oscar séduisent par leurs formes légèrement arrondies, leurs lignes intemporelles et sobres ainsi que leur discret relief sur la mitre du manche des couteaux. Grâce à leur esthétique universelle, ces couverts de table se combinent très facilement avec toutes les collections de vaisselle Villeroy & Boch.

Das Tafelbesteck der Kollektion Oscar besticht durch seine sanft abgerundeten Formen, zeitlos schlichte Linie und die dezente Prägung am Kropf des Messergriffs. Durch die universelle Formsprache lässt sich das Besteck sehr leicht mit allen Geschirr-Kollektionen von Villeroy & Boch kombinieren.

Los cubiertos de mesa de la colección Oscar impresionan por sus formas redondeadas suaves, la línea sencilla y atemporal y la discreta estampación en el borde del mango del cuchillo. Con un lenguaje de formas universal, esta cubertería se presta a combinarse sin problemas con cualquier vajilla de las colecciones de Villeroy & Boch.

Il servizio da tavola della collezione Oscar conquista con forme leggermente arrotondate, linee semplici e senza tempo e la sagomatura discreta sulla punta del manico del coltello. Grazie al linguaggio formale universale le posate si abbinano facilmente a tutte le collezioni di porcellane di Villeroy & Boch.



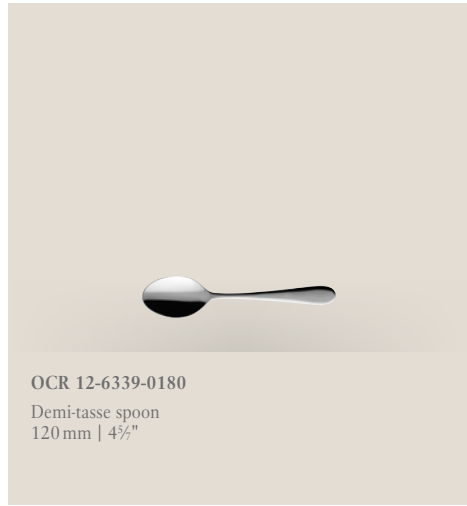
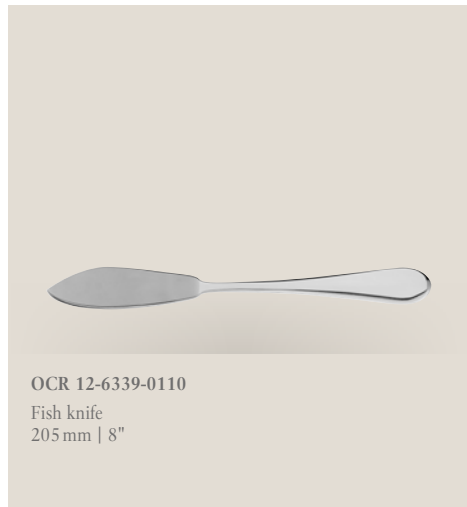
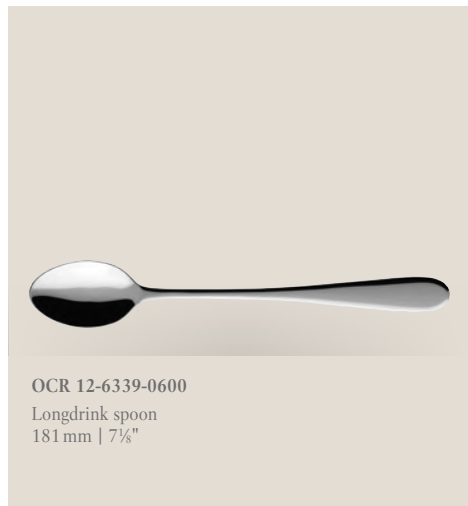



PIEMONTE

— Collection —

This cutlery collection is influenced by the baroque art form - just like the Italian region of Piedmont, the inspiration behind its name. The cutlery set impresses with moving curves and a slender shape. As a modern interpretation, the series is grand, delicate and minimalistic at the same time, creating a special atmosphere on any festive table.

Comme la région du Piémont italien, la collection de couverts de table du même nom est empreinte d'une forme d'art baroque. Ces couverts de table convainquent par leurs courbes mobiles et leur forme élancée. Réinterprétée de façon moderne, cette série à la fois splendide, délicate et minimaliste crée une atmosphère unique sur chaque table de fête.

Ebenso wie die italienische Region Piemont ist die gleichnamige Besteck-Kollektion von der barocken Kunstform geprägt. Das Tafelbesteck überzeugt mit bewegten Kurven und einer schlanken Form. Modern interpretiert wirkt die Serie prachtvoll, zart sowie minimalistisch zugleich und schafft eine besondere Atmosphäre auf jeder festlich gedeckten Tafel.

Al igual que en la región italiana del Piemonte, la cubertería del mismo nombre está trufada de arte barroco. La cubertería de mesa destaca por sus curvas en movimiento y su forma esbelta. Interpretada de forma moderna, la serie tiene un aspecto espléndido, delicado y minimalista a la vez, y crea un ambiente especial en toda mesa festiva.

Anche la regione italiana del Piemonte che dà nome alla collezione di posate è caratterizzata dall'arte barocca. Le posate convincono per le curve sinuose e la forma affusolata. Interpretata in chiave moderna, la serie ha un aspetto magnifico, delicato e minimalista allo stesso tempo e crea un'atmosfera speciale su ogni tavola apparecchiata a festa.







UDINE

— Collection —

The Udine cutlery series impresses with a feminine look, stylish shapes and a slightly dreamy style. The slender, linear handles feature a drop shape at the end that fits snugly in your hand. The shiny surface and slim silhouette give this cutlery collection a very delicate look.

La série de couverts de table Udine séduit par son design féminin, ses formes esthétiques et son charme onirique. Ses manches rectilignes d'une grande finesse se terminent en forme de goutte pour un toucher agréable. La surface brillante et les lignes élancées de cette collection de couverts de table lui confèrent un charme empreint de finesse.

Die Besteckserie Udine überzeugt mit einem feminin anmutenden, formschönen Design und einem leicht verträumten Flair. Die geradlinigen Besteckgriffe sind schlank gehalten und enden in einer handschmeichelnden Tropfenform. Durch die glänzende Oberfläche und die schmale Silhouette hat die Besteck-Kollektion eine sehr filigrane Anmutung.

La serie de cubiertos Udine destaca por un femenino y bonito diseño y un toque encantador. Los mangos rectilíneos de los cubiertos son finos y terminan en una gota que acaricia la mano. Gracias a su superficie brillante y a su fina silueta, esta serie de cubiertos se caracteriza por su sofisticada gracia.

La serie di posate Udine convince per il design femminile, la bella forma e richiama un po' un sogno. I manici lineari delle posate sono mantenuti sottili e terminano con una forma a goccia piacevole al tatto. Grazie alla superficie lucente e alla silhouette stretta la collezione di posate ha un aspetto molto filigranato.



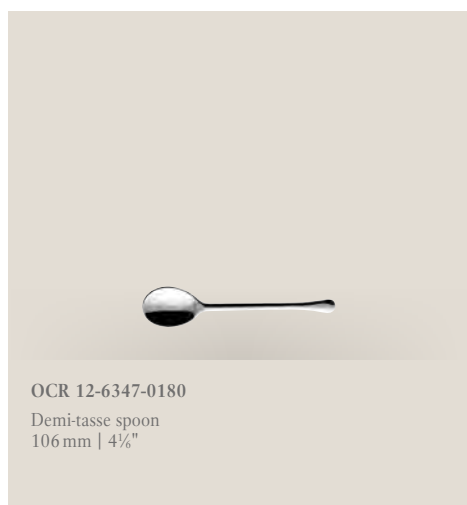
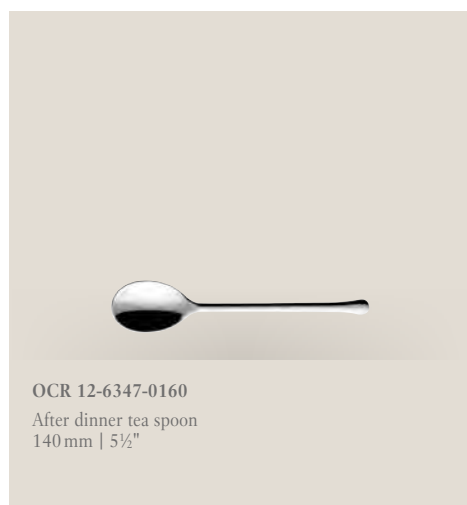
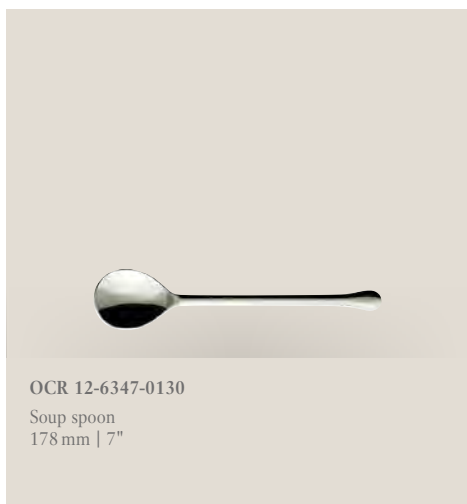
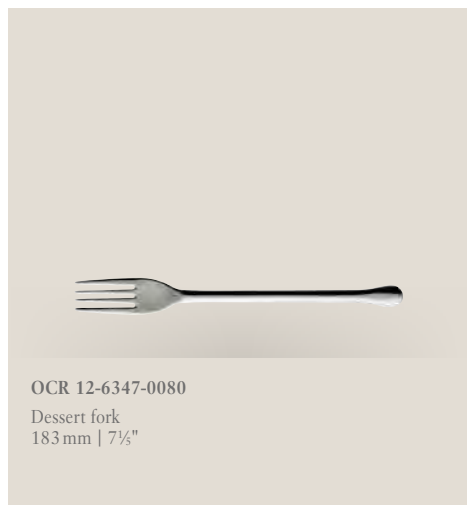
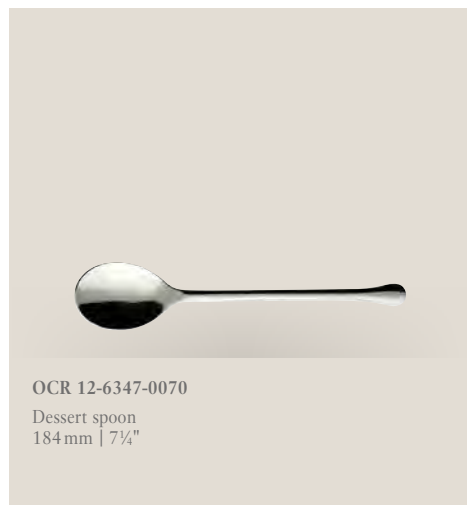
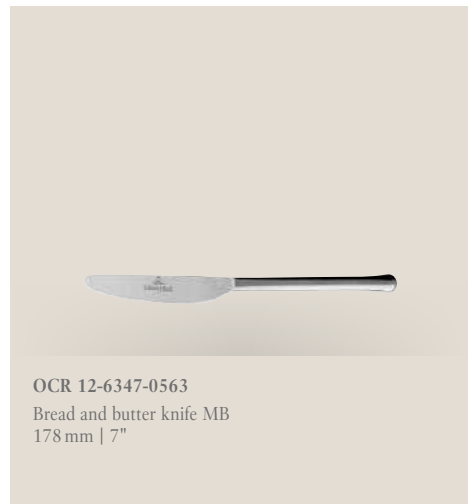



VICTOR

— Collection —

With its high-quality stainless steel, modern design and clear, angular lines, the Victor collection creates a very eye-catching effect on the table. The collection impresses with a classic, linear design enhanced with a modern curve at the end of the handle.

L'acier inoxydable de haute qualité, le design moderne et les lignes épurées et anguleuses de la collection Victor attireront tous les regards sur votre table. Cette collection se distingue par son style classique, rectiligne, et ses manches aux courbes modernes.

Hochwertiger Edelstahl, modernes Design und eine klare, kantige Linienführung machen die Kollektion Victor zu einem echten Hingucker auf der Tafel. Diese Kollektion glänzt durch ihre klassische, geradlinige Aufmachung, die durch einen modernen Schwung am Griffende aufgelockert wird.

Acero inoxidable de alta calidad, un diseño moderno y un trazado de líneas claro y con cantos, hacen que la colección Victor sea una auténtica atracción en la mesa. Esta colección sorprende por su apariencia clásica y las líneas rectas, que se suavizan mediante una curvatura de estilo moderno en el extremo del mango.

Pregiato acciaio inossidabile, design moderno e linee chiare con spigoli rendono la collezione Victor un vero richiamo visivo sulla tavola. Questa collezione risplende grazie alla sua veste classica e lineare che viene alleggerita da una moderna curvatura del manico.



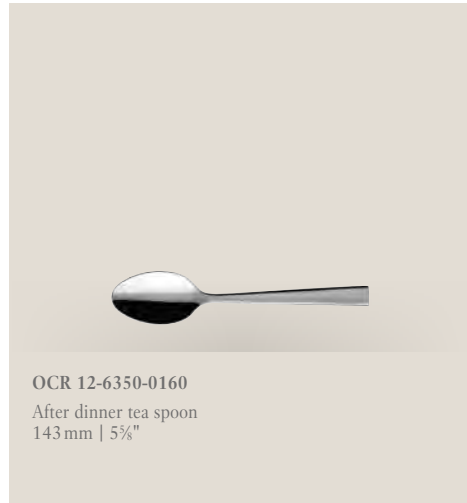
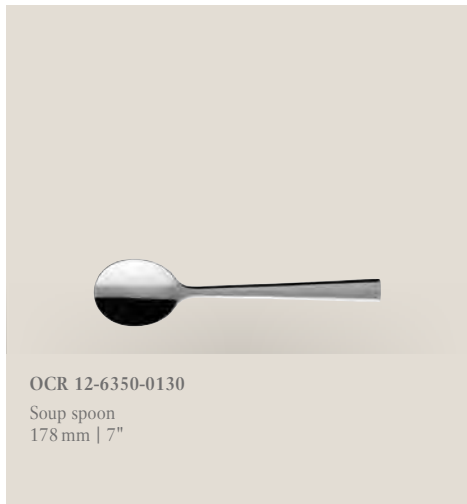
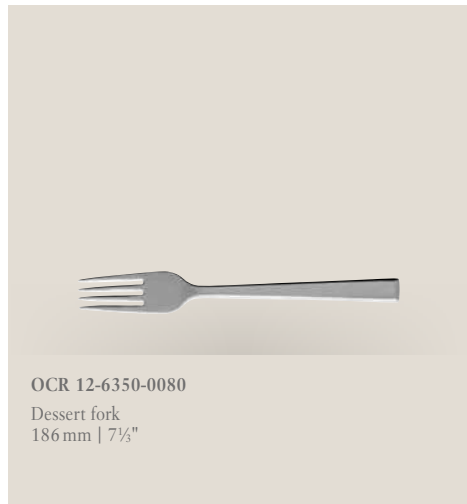



Glassware

The high-quality collections from Villeroy & Boch offer the right glasses for every dining situation. Whether all-rounders, special glasses or truly exquisite designs for upscale gastronomy – our extensive range offers the ideal combination of functionality and quality for committed restaurateurs.

Les collections de haute qualité de Villeroy & Boch proposent les verres parfaits quel que soit le type de repas. Qu'il s'agisse de verres polyvalents, de verres spéciaux ou du petit plus pour la gastronomie haut de gamme, notre vaste assortiment propose la combinaison idéale associant fonctionnalité et qualité pour des gastronomes passionnés.

Die hochwertigen Kollektionen von Villeroy & Boch bieten für jede Dining-Situation die richtigen Gläser. Ob Allrounder, Spezialgläser oder das gewisse Etwas für die gehobene Gastronomie – unser umfangreiches Sortiment liefert die ideale Kombination aus Funktion und Qualität für engagierte Gastronom:innen.

Las colecciones de alta calidad de Villeroy & Boch ofrecen las copas adecuadas para cualquier comida. Ya sean vasos polivalentes, vasos especiales o vasos con ese toque especial propio de la gastronomía de alto nivel, nuestra amplia gama ofrece la combinación ideal de funcionalidad y calidad para los gastrónomos y las gastrónomas más exigentes.

Le pregiate collezioni di Villeroy & Boch propongono i bicchieri giusti per ogni situazione culinaria. Che si tratti di bicchieri universali, speciali o di elementi particolari per la gastronomia di alto livello, la nostra vasta gamma offre la combinazione ideale di funzionalità e qualità per i ristoratori impegnati.





RANGE OVERVIEW



ENTREE
p. 274



LA DIVINA
p. 278



MAXIMA
p. 282



PURISMO
p. 286



BOSTON
p. 290



BOSTON COLOURED
p. 293



ENTRÉE

— Collection —

Whether dining, at a bar or banquet, Entrée is the perfect all-rounder for your all-day business. The simple design of the glasses and goblets makes them perfect for any occasion and draws attention to the exquisite beverages they contain.

Pour un dîner, un bar ou un banquet : Entrée est la collection polyvalente parfaite pour un usage quotidien. Le design simple de ses gobelets et verres à pied est idéal en toutes occasions et attire l'attention sur le vin raffiné se trouvant dans le verre.

Ob Dining, Bar oder Bankett: Entrée ist der perfekte Allrounder für das All Day Business. Das schlichte Design der Gläser und Kelche passt ideal zu jedem Anlass und lenkt die Aufmerksamkeit auf die edlen Tropfen im Glas.

Para comedores, bares o banquetes: Entrée es una serie versátil y perfecta para cualquier momento del día. El diseño sencillo de los vasos y las copas es ideal para cualquier ocasión y convierte en protagonistas a las elegantes gotas del vaso.

Cena, bar o banchetto? Entrée è la soluzione universale per le attività quotidiane. Il design sobrio dei bicchieri e dei calici è ideale per ogni occasione e richiama l'attenzione sul ricercato contenuto del bicchiere.





OCR 11-3658-7808
Red wine goblet, set 4 pcs.
198 mm · 0,48l | 7½" · 16 oz.



OCR 11-3658-7818
White wine goblet, set 4 pcs.
186 mm · 0,3l | 7½" · 10 oz.



OCR 11-3658-7809
Champagne flute, set 4 pcs.
205 mm · 0,25l | 8" · 8½ oz.



OCR 11-3658-7864
Brandy glass, set 4 pcs.
132 mm · 0,4l | 5½" · 13½ oz.



OCR 11-3658-7866
Sherry glass, set 4 pcs.
169 mm · 0,1l | 6½" · 3½ oz.



OCR 11-3658-7867
Beer goblet, set 4 pcs.
185 mm · 0,42l | 7½" · 14½ oz.



OCR 11-3658-7894
Glass 1, set 4 pcs.
100 mm · 0,57l | 4" · 19½ oz.



OCR 11-3658-7826
Glass 2, set 4 pcs.
110 mm · 0,48l | 4½" · 16½ oz.



OCR 11-3658-7895
Glass 3, set 4 pcs.
143 mm · 0,62l | 5½" · 21 oz.



LA DIVINA

— Collection —

Special occasions call for special glasses that can turn every reception into a dazzling success. The timeless La Divina collection is tailored to sophisticated tastes. The rounded shape of the glasses allows the bouquet of full-bodied wines and smoky whisky to develop and beautifully showcases sparkling champagne.

Les occasions spéciales exigent des verres originaux afin que chaque réception soit un véritable succès. Avec la collection intemporelle La Divina, vous satisferez aux exigences les plus élevées. La forme bombée des verres permet au bouquet des vins ou des whiskys fumés de s'épanouir pleinement et met habilement en scène des champagnes pétillants.

Besondere Anlässe verlangen nach besonderen Gläsern, die jeden Empfang zu einem vollen Erfolg werden lassen. Mit der zeitlosen Kollektion La Divina werden Sie jedem gehobenen Anspruch gerecht. Die bauchige Form der Gläser entfaltet das Bouquet vollmundiger Weine, sowie rauchigen Whiskys und setzt prickelnden Champagner gekonnt in Szene.

Las ocasiones especiales merecen unos vasos especiales que conviertan cada recepción en un gran éxito. La colección atemporal La Divina satisface los requisitos más exigentes. La forma protuberante de los vasos ayuda a desplegar el aroma de los mejores vinos, el vaho del whisky o el chisporroteo del champán.

Per le occasioni speciali sono necessari bicchieri altrettanto speciali, perché ogni ricevimento abbia successo. Con la collezione senza tempo La Divina soddisferete i più esigenti. La forma bombata dei bicchieri lascia sprigionare il bouquet di vini corposi e di whisky dall'aroma affumicato e valorizza sapientemente spumeggianti champagne.





OCR 16-6621-0021
Burgundy wine goblet
243 mm · 0,681 | 9 1/2" · 23 oz.



OCR 16-6621-0020
Red wine goblet
235 mm · 0,471 | 9 1/4" · 15 1/2 oz.



OCR 16-6621-0130
Water/Bordeaux wine goblet
252 mm · 0,651 | 10" · 22 oz.



OCR 16-6621-0035
White wine goblet
227 mm · 0,381 | 9" · 12 1/2 oz.



OCR 16-6621-0072
Champagne flute
232 mm · 0,261 | 10" · 8 1/2 oz.



OCR 16-6621-1300
Water goblet
145 mm · 0,331 | 5 1/2" · 11 1/2 oz.



OCR 16-6621-1410
Whisky tumbler
94 mm · 0,361 | 3 3/4" · 12 1/2 oz.

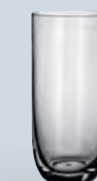

OCR 16-6621-3660
Longdrink glass
149 mm · 0,441 | 5 7/8" · 14 1/2 oz.



MAXIMA

— Collection —

Stylish wine enjoyment for discerning guests. The shape of every glass was specially designed to skilfully emphasise the best characteristics of wine and champagne. The elegant, voluminous goblets are therefore ideal for celebrating with especially fine drinks.

Une dégustation du vin pour les clients les plus exigeants. La forme de chaque verre a été spécialement conçue pour mettre habilement en avant les meilleures propriétés du vin et du champagne. Leurs calices élégants et volumineux sont ainsi parfaits pour mettre à l'honneur des vins raffinés.

Stilvoller Weingenuss für anspruchsvollen Gäste. Die Form eines jeden Glases wurde speziell dafür design, die besten Eigenschaften von Wein und Champagner gekonnt in den Vordergrund zu rücken. Die eleganten, großvolumigen Kelche eignen sich somit hervorragend zum Zelebrieren besonders edler Tropfen.

Para disfrutar del vino con mucho estilo y con los invitados más exigentes. La forma de cada uno de sus vasos está diseñada especialmente para sacar lo mejor del vino y el champán. Las elegantes copas de gran volumen son, por tanto, ideales para tomar vinos muy refinados.

Tutto il piacere del vino con stile per i vostri ospiti più esigenti. La forma di ogni singolo bicchiere è stata disegnata appositamente per esaltare in modo sapiente le caratteristiche migliori di vino e champagne. I calici eleganti e dalle grandi dimensioni sono quindi ideali per esaltare vini particolarmente pregiati.





OCR 11-3731-0010
 Bordeaux wine glass
 252 mm · 0,65l | 10" · 22 oz.



OCR 11-3731-0011
 Burgundy wine goblet
 225 mm · 0,79l | 8 5/8" · 26 1/2 oz.



OCR 11-3731-0031
 White wine goblet
 240 mm · 0,37l | 9 1/2" · 12 1/2 oz.



OCR 11-3731-0072
 Champagne flute
 265 mm · 0,15l | 10 1/2" · 5 oz.



PURISMO

— Collection —

Purismo offers beautiful wine goblets as well as stylish glasses for sparkling champagne and elaborate spirits, which can develop their full sensory character thanks to the clear, reduced design. This elegantly simple glass range is designed for maximum pleasure.

Purismo propose des beaux verres à vin ainsi que des verres élégants pour le champagne pétillant et les spiritueux sophistiqués qui développeront tout leur caractère sensoriel grâce à leur design net et épuré. Une gamme élégante et simple pour le plaisir à l'état pur.

Purismo bietet formschöne Weinkelche sowie stilvolle Gläser für spritzigen Champagner und aufwendige Spirituosen, die dank des klaren, reduzierten Designs ihren vollen sensorischen Charakter entfalten. Die elegante, unkomplizierte Glaslinie für puren Genuss.

Purismo ofrece copas de vino de formas bonitas, así como elegantes copas para champán y licores de lujo, que desarrollan todo su carácter sensorial gracias a su diseño claro y reducido. Una cristalería elegante y sencilla para el puro placer.

Purismo propone calici da vino delle forme accattivanti e bicchieri eleganti per champagne frizzante e liquori elaborati, che dispiegano il loro pieno carattere sensoriale grazie al design chiaro e sobrio. Una linea di bicchieri elegante e semplice da gustare al meglio..







BOSTON

— Collection —

Whether in red, blue, green or transparent: the glasses of the Boston collection are true all-rounders. The striking, faceted pattern and the robust, high-quality crystal glass make this glass series an attractive highlight in any setting.

En rouge, en bleu, en vert ou transparents: les verres de la collection Boston sont de véritables articles polyvalents. Avec leur motif à facettes expressif et leur cristallin robuste de haute qualité, ces verres attirent tous les regards quelle que soit la situation.

Ob in Rot, Blau, Grün oder Transparent: Die Gläser der Kollektion Boston sind ein wahrer Allrounder. Ein ausdrucksstarkes Facettenmuster und das robuste, hochwertige Kristallglas machen die Glasserie in jeder Situation zu einem attraktiven Blickfang.

Ya sean rojos, azules, verdes o transparentes, los vasos de la colección Boston son muy versátiles. Su expresivo patrón facetado y su sólido vidrio de cristal de alta calidad hacen que la colección de cristalería sea el centro de todas las miradas en cualquier situación.

Rossi, blu, grigi o trasparenti: I bicchieri della collezione Boston rappresentano la versatilità per eccellenza. Un motivo variegato espressivo e cristallo robusto di alta qualità rendono la serie di bicchieri un accattivante richiamo visivo in qualsiasi situazione.



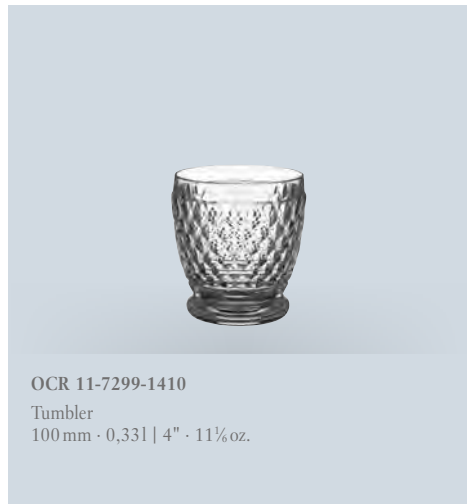
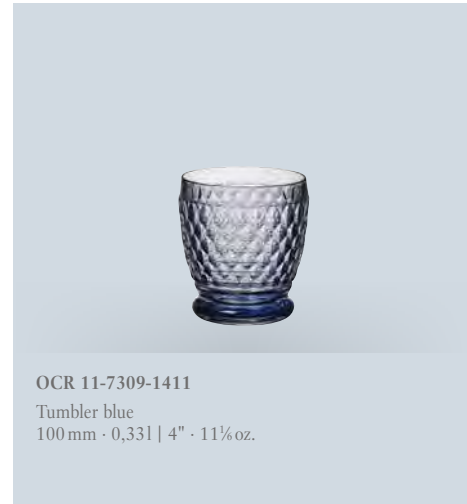
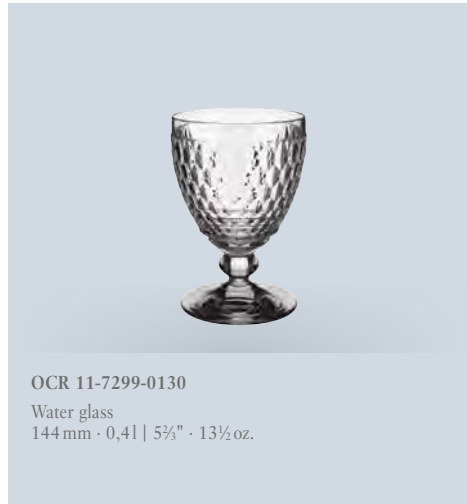
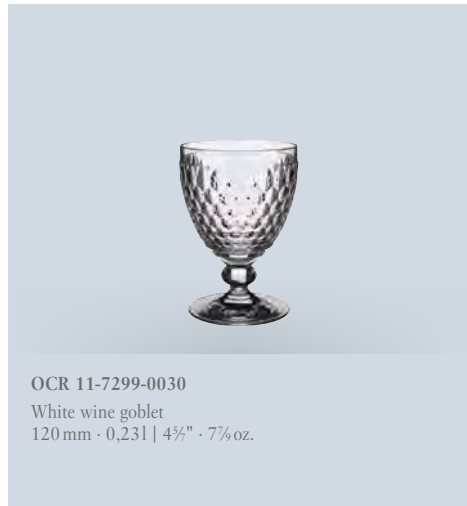
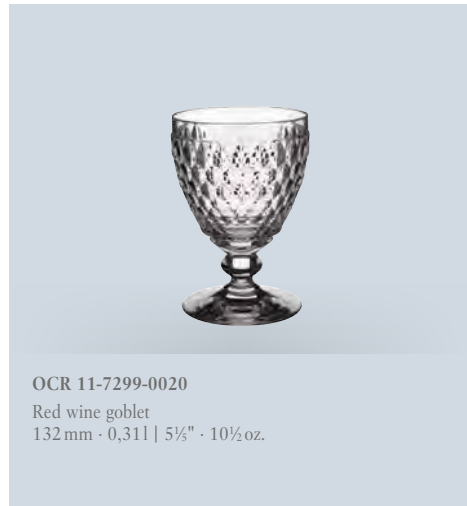



SALES CONTACT

HEADQUARTER/LUXEMBOURG

Villeroy & Boch S.à.r.l. · Hotel & Restaurant
330, Rue de Rollingergrund
2441 Luxembourg
Tel.: +(352) 468211 · Fax: +(352) 469022
E-mail: info.hr@villeroy-boch.com
www.villeroy-boch.com/hospitality

ARMENIA

A. Manukyan
Safetrade Handels Import Export GmbH
Leipziger Platz 10 · D-10117 Berlin
Tel.: +(49) 3020670895-0
Fax: +(49) 3020670895-20
E-mail: arayik.manukyan@safetrade-gmbh.de

AUSTRALIA & NEW ZEALAND

Food Equipment International
5/107 Carnarvon Street · Silverwater
2128 Sydney
Tel.: +612 99385000 · Fax: +612 99385055
E-mail: info@fei.com.au

AUSTRIA

Villeroy & Boch Austria Ges.m.b.H.
Söllheimerstraße 16 · Gebäude 6D OG 3/4 · 5020
Salzburg
Tel.: +(43) 662660212-11 · Fax: +(43) 662660216
E-mail: fischer.arthur@villeroy-boch.com

AZERBAIJAN

Mr. Ahmet Uestuen
Area Sales Manager Central Asia
Villeroy & Boch | Hotel & Restaurant
Mobile TUR: +905322260230
E-Mail: ustun.ahmet@villeroy-boch.com

Italdizain Group

Uzeyir Hajibeyli, 77A
AZ-1000 Baku · Azerbaijan
Tel.: +994125990013/14/23, 4989661
E-mail: l.ismailov@italdizain.az

BAHRAIN

Gulf Supplies
34 Tariq Building, Government Avenue,
Manama 315 · Kingdom Of Bahrain
Tel.: +(973) 17213881
E-mail: tanvir@gulfsupplies.biz

BELGIUM

Villeroy & Boch SA
Avenue Louise 37
B-1050 BRUSSELS
Mobile: +31621712785
E-mail: gunther.monique@villeroy-boch.com

NKZ, de Kortrijkse Zilvercentrale
Sint Anna 35
B-8500 Kortrijk
Tel.: +3256353558
E-mail: info@nkz.be
Website: www.nkz.be

ProDish NV
Bedrijvenparc NELCA ZUID
Stationsstraat 80C
B-8860 LENDELEDE
Tel.: +3251622886
E-mail: Info@prodish.be
Website: www.prodish.be

BULGARIA

Dotel Ltd.
Diana Kostova
Str. OTEZ PAISY 44 ,1st Level · 1303 SOFIA
Tel. Showroom: +35929640955
Tel. Sales Department: +359898621253
Mobile: +359888570604
E-mail: doteldiana@hotmail.com
doteltosh@hotmail.com
www.dotel.bg

CANADA

Tableware Solutions Ltd.
Bill Horosko
4524 Eastgate Parkway
Mississauga, ON, L4W 3W6
Tel.: +(1) 905629-9555 · Fax: +(1) 905629-1905
Website: www.tablewaresolutions.com

CHINA

Villeroy & Boch AG (Shanghai) Representative Office
10F, Jing Hong Qiao Business Building
No. 8 · Lane 555 · Gubei road · Chang Ning District
20051 Shanghai · PR China
Tel.: +842162363281*8009
Fax: +842162363283
E-mail: Qi.Leo@villeroy-boch.com

CROATIA

Zagreb Office:
Ital-Opremanje d.o.o.
Gabrijela Šolčić
Turanjska 15 · 10020 Zagreb · Hrvatska / Croatia
Tel.: +385 (0)16594660
Mobile: +385 (0)98338049
E-mail: gabi.solcic@ital-opremanje.hr
Website: www.ital-opremanje.hr

Split Office:
Ital-Opremanje d.o.o.
Vesela Šamija
4.Gardijske brigade 3021311 Stobreč
Hrvatska / Croatia
Tel.: +385 (0)21787470
Mobile: +385 (0)914455459
E-mail: vesela.samija@ital-opremanje.hr
Website: www.ital-opremanje.hr

CYPRUS

Loris Constantinou & Co. Ltd.
27 Le Corbusier Str. · P.O. Box 56553
3308 Limassol
Tel.: +(357) 25822747 · Fax: +(357) 25339288
E-mail: costas@lcy-ltd.com

SALES CONTACT

CZECH REPUBLIC

Potten & Pannen - Staněk group, spol. s r.o.
Obchodní 110 · 25101 Čestlice
Tel.: + (420) 261227373
Mobile: + (420) 7258000900
E-mail: pavel.kubat@pottenpannen.cz

DENMARK

H.W. Larsen A/S
Slagterboderne 15-21 · Købbyen · 1716 København V
Tel.: +(45) 33241122
E-mail: salg@hwl.dk
Website: www.hwl.dk

EGYPT

EITS - Egyptian International for Trading & Supplies
Abdullah Soliman
7 Gameat Aldewal Al Arabia St.,
Mohandessein · Giza
Tel.: + +2 (03)3 4444 58
E-mail: abdullah.soliman@eitsemotions.net

ESTONIA

Restatrade OÜ
Suur-Sõjamäe 13a
11415 TALLINN
Tel. +37253426581
E-mail: liljana@restatrade.ee
Website: www.restatrade.ee

FINLAND

Villeroy & Boch Tableware Oy
Tel: +(358) 409006767
E-mail: kurki.petteri@villeroy-boch.comm

Kesko Corporation Kespro

Tel: +(358) 105324240
E-mail: kespro.myynti@kesko.fi

FRANCE

Villeroy & Boch Arts de la Table S.A.
82, rue d'Hauteville · F-75010 Paris
Tel.: +(33) 610220382 · Fax: +(33) 144791564
E-mail: scherlen.gregory@villeroy-boch.com

GEORGIA

Mr. Ahmet Uestuen
Area Sales Manager Central Asia
Villeroy & Boch | Hotel & Restaurant
Mobile: +(90) 5322260230
E-Mail: ustun.ahmet@villeroy-boch.com

Luxury Interior Ltd

1, Rustaveli Ave.
0105 Tbilisi · Georgia
Tel.: +995322 934734
Mobile: +995577996995
E-mail: maiagogiashvili@luxury-interior.ge
natiakhubua@luxury-interior.ge

GERMANY

Villeroy & Boch AG
Hotel & Restaurant Vertriebsleitung Deutschland
Rieffstraße 46 · 66663 Merzig
Service Hotline: +(49) 8001013885
Fax: +(49) 8001013886
E-mail: hotel.deutschland@villeroy-boch.com

GREECE

Filippos Paraskevoulakos
Horeca Equipment Agency
Mobile.: +(30) 6944381607
E-mail: paraskevoulakos.filippos@villeroy-boch.com

HONG KONG

Mr. Jean-Pierre Blanchet
Villeroy & Boch APAC
E-Mail: blanchet.jean-pierre@villeroy-boch.com

Ming Fai Asia Pacific Company Limited

Unit D3, 8/F · TML Plaza, No. 3
Hoi Shing Road · Tsuen Wan
Hong Kong
Tel.: +85263077238
E-mail: alice.chen@mingfaigroup.com

HUNGARY

Dajar Kft.
Jászberényi út 45
1106 Budapest
Tel.: +36304198958
E-mail: maria.sandor@dajar.hu

ICELAND

Bako Isberg ehf
Höfðabakka 9
110 REYKJAVIK
Tel. +3545956200
E-mail: pontun@bakoisberg.is
Website: www.bakoisberg.is

INDIA

Mr. Jean-Pierre Blanchet
Villeroy & Boch APAC
E-mail: blanchet.jean-pierre@villeroy-boch.com

INDONESIA

Mr. Jean-Pierre Blanchet
Villeroy & Boch APAC
E-mail: blanchet.jean-pierre@villeroy-boch.com

IRAQ

Samawar Hospitality Ltd.
100s Street · Opposite Erbil International Airport
Erbil / Iraq
Mobile: +(964) 7508990550
E-mail: raid@samawar-iraq.com

ISRAEL

Millennium Marketing
37, Sheerit Israel Str. 68
16522 Tel Aviv
Tel.: +9723-5181558
E-Mail: Dani@mil-m.co.il

ITALY

Abert S.p.A. Divisione Broggi 1818
Via Don Primo Mazzolari, 17 · 25050 Passirano (BS)
Tel.: +(39) 0306853601 · Fax: +(39) 0306853610
E-mail: vittorio.rossetti@abert.com
Website: www.broggi.com

JAPAN

Mr. Jean-Pierre Blanchet
Villeroy & Boch APAC
E-Mail: blanchet.jean-pierre@villeroy-boch.com

Sanyei Corporation

4-1-2 Kotobuki
111-8682 Taito-ku · Tokyo
Tel.: +813 38476860 · Fax: +813 38476861
E-mail: hiddenori.nazuka@essencorp.co.jp

JORDAN

United Trading for Porcelain & Art
Sweifeih-Al-Hamra Street · P.O. Box 2642
11181 Amman
Tel.: +(962) 65818855/65812225
Fax: +(962) 65850491
E-mail: utpa@swaiss.com

KAZAKHSTAN

Mr. Ahmet Uestuen
Area Sales Manager Central Asia
Villeroy & Boch | Hotel & Restaurant
Mobile: TUR: +(90) 5322260230
E-Mail: ustun.ahmet@villeroy-boch.com

KOREA

Mr. Jean-Pierre Blanchet
Villeroy & Boch APAC
E-Mail: blanchet.jean-pierre@villeroy-boch.com

Taco Trading Co.

203 Dai-Ho Bldg · 136-5 Yenji-Dong
Chongro-Gu
Seoul · South Korea · 110-470
Tel.: +(82) 27656523 / 27448307
Fax: +(82) 27656524
E-mail: tacotrading.co@gmail.com

SALES CONTACT

KUWAIT

Mr. Ahmet Uestuen
Area Sales Manager Central Asia
Villeroy & Boch | Hotel & Restaurant
Mobile: +(90) 5322260230
E-Mail: ustun.ahmet@villeroy-boch.com

LATVIA

Villeroy & Boch Tableware
Tel: + 358409006767
E-mail: kurki.petteri@villeroy-boch.com

LEBANON

MG Hotel Supplies S.A.L
21, Unico Building · Street 72
Sector 1 · Mkalles
Beirut · Lebanon
Tel.: +(961) 1694194
E-mail: info@mghotelsupplies.com

LITHUANIA

Villeroy & Boch Tableware
Tel: + 358409006767
E-mail: kurki.petteri@villeroy-boch.com

LUXEMBOURG

Villeroy & Boch S.à.r.l.
Hotel & Restaurant
330, Rue de Rollinggrund
2441 Luxembourg
Tel.: +(352) 46821208 · Fax: +(352) 46821711
E-mail: schmitz.georges@villeroy-boch.com
Website: www.villeroy-boch.com/hospitality

MALAYSIA

Mr. Jean-Pierre Blanchet
Villeroy & Boch APAC
E-mail: blanchet.jean-pierre@villeroy-boch.com

LCS Hospitality Solutions

No. 11A · PJS 7/19 · Bandar Sunway
Selangor Darul Ehsan
46150 Petaling Jaya
Tel.: +60356127188
E-mail: sales@lauchoyseng.com

MALTA

Continental Purchasing Co. Ltd.
53 Mediterranean Buildings · Ground Level
Abate Rigord Street · Ta Xbiex XBX 1122
Tel.: +(356) 21330263
Fax: +(356) 21343861
E-mail: mcianter@cpc.com.mt

MAROCCO

Villeroy & Boch Arts de la Table S.A. - France
Tel.: +(33) 610220382
E-mail: scherlen.gregory@villeroy-boch.com

MEXICO

Proepta, S.A. de C.V.
Galileo No. 11
Col.Polanco V Seccion Deleg
11560 Miguel Hidalgo; Mexico
Tel.: +(52) 55416222227 · Fax: +(52) 55751044
E-mail: nathan.israel@proepta.mx

MONGOLIA

Mr. Jean-Pierre Blanchet
Villeroy & Boch APAC
E-mail: blanchet.jean-pierre@villeroy-boch.com

MONTENEGRO

Cubico d.o.o.
Bulevar Džordža Vašingtona 3/9
ME-81000 Podgorica
Tel./Fax: +(382) 20228181
Mobile: +(382) 67228181
E-mail: info@cubico.co.me
Website: www.cubico.co.me

NETHERLANDS

Villeroy & Boch Tableware BV
Miele Experience Center Vianen
De Limiet 2
NL - 4131 NR Vianen
Tel.: +31621712785
E-mail: gunther.monique@villeroy-boch.com

SALES CONTACT

NETHERLANDS

Bender Foodservice Equipment

Tiber 96

NL-2491 DK DEN HAAG · Foreparc

Tel.: +31703174310

E-mail: info@bender.nl

Website: www.bender.nl

HANOS Nederland

Stadhoudersmolenweg 41

NL-7317 AW APELDOORN

Tel.: +31555294646

E-mail: info@hanos.nl

Website: www.hanos.nl

J. van Doorn BV

Oppermanstraat 33

3194 AC HOOGVLIET (Rotterdam)

Tel.: +31104663220

E-mail: info@vandoornbv.nl

Website: www.vandoornbv.nl

Sligro

Corridor 11

NL - 5466 RB VEGHEL

Tel.: +31413343500

E-mail: info@sligro.nl

Website: www.sligro.nl

NORTHERN IRELAND & REPUBLIC OF IRELAND

Bunzl McLaughlin Ltd.

35 Moy Road

Armagh BT618DL

Tel.: +(353) 2837511999

Mobile: +(353) 4837511999

E-mail: bmlmarketing@bunzl.ie

Hugh Jordan and Co.

Unit 4 Airways Industrial Estate

Santry · Dublin 17

Tel.: +(353) 18627200 · Fax: +(353) 18627277

E-mail: sales@hughjordan.com

NORWAY

Villeroy & Boch Tableware Oy

Tel: +(358) 409006767

E-mail: kurki.petteri@villeroy-boch.com

OMAN

Mr. Ahmet Uestuen

Area Sales Manager Central Asia

Villeroy & Boch | Hotel & Restaurant

Mobile TUR: +905322260230

E-Mail: ustun.ahmet@villeroy-boch.com

Hospitality Supplies International

Post Box: 79, P.C. 117, Office No.2, Saar House,

Way 3510 MBD South, Muscat,

Sultanate of Oman

Tel.: +96824813330

Email: info@hsi-intl.com

PAKISTAN

Anis Ahmed & Brothers

4J.C.H. Society · Block 7/8 · Sharea Faisal

75350 Karachi

Tel.: +(92) 214545912 · Fax: +(92) 214545905

E-mail: aabros@aabros.com.pk

PHILIPPINES

Mr. Jean-Pierre Blanchet

Villeroy & Boch APAC

E-mail: blanchet.jean-pierre@villeroy-boch.com

POLAND

Tableart Tomasz Miszczak

Kutrzeby 14

61-719 Poznan

Poland

Email: tmiszczak@miszczak.biz

PORTUGAL

Exclusivas irei

Avenida de Andalucia km 10, 500

Poligono NEISA SUR

C/Transversal Segunda, edificio 5 Nave 10

28021 Madrid

Tel.: +(34) 609081440

E-mail: ignacio.riva@irei.es

QUATAR

Montemare Trading W.L.L

Stanlli Office Bldg.10, First Floor,

Office No.104 Ibn Seena St,

Al Mountaza Area · 45160 Doha

Tel.: +97444150216

E-mail: vasu@montemaretrading.com

REPUBLIC OF MACEDONIA:

Evroporc Doo

Street 1 · number 2v · Trubarevo Skopje

Mikle Spasovski + 38970220151

Tel.: +3892 557201

E-mail: office@evroporc.com.mk

www.evroporc.com.mk

RUSSIA

Forenkom

57 Profsoiuznaya str. · 129110 Moscow

Tel.:+7495719787/ +749571862001

Fax: +74957197992

E-mail: irina@v-b.ru

SAUDI ARABIA

Saudi Arabia Agencies Ltd. (SARA)

SARA Jeddah Office:

Arafat Street, Hamra District,

Jeddah- 21461, K.S.A

Tel.: + (966) 26605033

E-mail: mohammed.tahhan@saragroup.com

SINGAPORE & SOUTH-EAST ASIA

Mr. Jean-Pierre Blanchet

Villeroy & Boch APAC

E-mail: blanchet.jean-pierre@villeroy-boch.com

SLOVAKIA

Nimes s.r.o · Einsteinova 9 · 85212 Bratislava

Tel.: +(421) 910613993 · Fax: +(421) 263451477

E-mail: obchod@nastol.sk

SLOVENIA

Arona tm

Ob železnici 22 · 1000 Ljubljana

Tel.: +38651880088

E-mail: info@arona.si

Website: www.arona.si

SOUTH AFRICA

JCP Hotelware

7405 Western Cape – South Africa

Tel: +(27) 870572603

E-mail: Contact@jcphotelware.com

SPAIN

Exclusivas irei

Avenida de Andalucia km 10, 500

Poligono NEISA SUR

C/Transversal Segunda, edificio 5 Nave 10

28021 Madrid

Tel.: +(34) 609081440

E-mail: ignacio.riva@irei.es

SRI LANKA

M.C. Abdul Rahim & Bro. (Pvt) Ltd

No. 14, Rotunda Gardens,

Colombo 03 · Sri Lanka

Tel.: +(94) 11434383942

E-mail: bary@abduhrahims.com

SWEDEN

Villeroy & Boch Nordic AB

Nybrogatan 24 · 11439 Stockholm

Tel.: Tel +468 57039480

E-mail: kurki.petteri@villeroy-boch.com

SWITZERLAND

Villeroy & Boch Creatable Hotel

Bahnhofstrasse 6 · 5600 Lenzburg

Tel.: +(41) 628863836 · Fax: +(41) 628863888

E-mail: grieder.felix@villeroy-boch.com

SALES CONTACT

TAIWAN

Mr. Jean-Pierre Blanchet

Villeroy & Boch APAC

E-mail: blanchet.jean-pierre@villeroy-boch.com

THAILAND

Villeroy & Boch (Thailand) Co., Ltd. – APAC Regional

Office

65/42 Rama9 Road, HuayKwang, Bangkok 10310

Tel.: +6622063400

Mr. Jean-Pierre Blanchet

Villeroy & Boch APAC

E-Mail: blanchet.jean-pierre@villeroy-boch.com

TURKEY

Mr. Ahmet Uestuen

Area Sales Manager Central Asia

Villeroy & Boch | Hotel & Restaurant

Mobile LUX: +(352) 621174820

E-Mail: ustun.ahmet@villeroy-boch.com

Galeri KristalIstanbul Showroom

Bahariye Cad. No: 22

34440 KASIMPAŞA / İSTANBUL

Turkey

Tel.: +902122358989

E-mail: info@galerikristal.com.tr

TUNISIA

Villeroy & Boch Arts de la Table S.A. - France

Tel.: +(33) 610220382

E-mail: scherlen.gregory@villeroy-boch.com

UKRAINE

Mirs Corporation

Ukraine 65012 · Odessa

37 Osipova Str. · Office 551

Tel.: +(00)380482305508

Fax: +(00)380482305555

E-mail: mirs@tango.com.ua

Website: www.mirs.com.ua

UNITED ARAB EMIRATES

Sara Hospitality

Eiffel 2 Building, Umm Al Sheif,

Sheikh Zayed Road,

Dubai, U.A.E

Tel.: +(971) 43856970

E-mail: mohammed.tahhan@saragroup.com

UNITED KINGDOM

Villeroy & Boch (UK) Limited

306-308 Chelsea Design Centre East

Chelsea Harbour

London SW100XF

Tel.: +(44) 2088710011

E-mail: hotel@villeroy-boch.co.uk

USA

Villeroy & Boch Tableware Division

3A South Middlesex Avenue

Monroe Twp. · NJ 08831

Tel.: +(1) 6095784300 · Fax: +(1) 6096552405

E-mail: hotel-r@villeroy-boch-usa.com

VIETNAM

Mr. Jean-Pierre Blanchet

Villeroy & Boch APAC

E-mail: blanchet.jean-pierre@villeroy-boch.com

Care

INSTRUCTIONS

CARE INSTRUCTIONS FOR PORCELAIN

- Select a low temperature programme for a mild wash.
- Because of regional variation in the quality of water, make sure sufficient decalcifying agent is used.
- Take care when arranging the items in the dishwasher, chips and cracks occur often at this stage.
- Observe the manufacturer's advice on wash time and quantity of detergent.
- Large solid objects should be washed by hand.
- Open the dishwasher once the wash cycle is over to allow the steam to escape and prevent condensation from forming.

CARE INSTRUCTIONS FOR CUTLERY

- Wash immediately after use. If cutlery is left unwashed over a lengthy period, acids from food residue can attack the oxide layer protecting the rust-proof stainless steel.
- Similarly, the risk of tarnishing can be avoided by washing the cutlery immediately.
- Place the cutlery in the cutlery basket with the handles pointing downwards - upright and unsorted, thus enabling the water jets to access all soiled parts in optimum effect.
- Remove the cutlery immediately from the dishwasher as soon as the washing cycle is complete; items that are still damp should be wiped dry.

CARE CONSTRUCTIONS FOR DRINKING GLASSES

- To avoid breakage during the wash place the glasses so that they don't touch each other.
- Always put the glasses in the upper compartment.
- Stemmed glasses shouldn't be placed in the corners in order to let the washing liquid reach all items.
- To keep the shininess of your glasses respect the washing programs, the amount of detergents, the temperature and check the mildness of the water.
- Rather choose a short and low temperature program.
- Respect the given quantity for detergents and use a special glass agent to preserve your glasses.
- The detergents shouldn't contain any sand and should be soft to not damage the glasses.
- Fill the salt compartment regularly to milder the water and avoid limescale marks.
- Keep filter, helix and pipes clean.
- At the end of the cycle open the dishwasher during 5-10 minute to avoid marks left on the glasses by the steam.
- Hold the glasses by the bottom when putting them away to avoid finger marks.
- Glasses with gold or silver pattern as well as hand painted should be washed by hand.





Villeroy & Boch S.à.r.l. · Hospitality
330, rue de Rollingergrund
L-2441 Luxembourg
Tel.: + (352) 468211
Fax: + (352) 469022
E-Mail: info.hr@villeroy-boch.com

 villeroyboch.com/hospitality

 [instagram.com/villeroyboch](https://www.instagram.com/villeroyboch)

 [facebook.com/villeroyandboch](https://www.facebook.com/villeroyandboch)

 [pinterest.com/villeroyandboch](https://www.pinterest.com/villeroyandboch)

